



FIXADORES

ARRUELA LISA



Polida



Zincada

CÓD.	DESCRIÇÃO	EMB.
21460	ARRUELA LISA A 1/8 X 1,0 ZINC	KG
17291	ARRUELA LISA A 5/32 X 1,0 C/910	KG
26479	ARRUELA LISA A 5/32 X 1,2 ZIN	KG
17292	ARRUELA LISA B 3/16 X 1,2 C/670	KG
17303	ARRUELA LISA B 3/16 X 1,2 ZIN	KG
17293	ARRUELA LISA C 1/4 X 1,2 C/460	KG
17304	ARRUELA LISA C 1/4 X 1,2 ZINC	KG
17294	ARRUELA LISA C 5/16 X 1,2 C/300	KG
17305	ARRUELA LISA C 5/16 X 1,2 ZIN	KG
21804	ARRUELA LISA C 5/16 X 2,0	KG
1553	ARRUELA LISA C 5/16 X 2,0 ZINC	KG
17295	ARRUELA LISA D 3/8 X 1,2 C/205	KG
17306	ARRUELA LISA D 3/8 X 1,2 ZINC	KG

CÓD.	DESCRIÇÃO	EMB.
17431	ARRUELA LISA D 3/8 X 2,0	KG
20340	ARRUELA LISA D 3/8 X 2,0 ZINC	KG
17296	ARRUELA LISA E 7/16 X 1,9 C/160	KG
17307	ARRUELA LISA E 7/16 X 1,9 ZIN	KG
17297	ARRUELA LISA F 1/2 X 3,0 C/70	KG
17308	ARRUELA LISA F 1/2 X 3,0 ZINC	KG
17298	ARRUELA LISA G 9/16 X 3,0 C/60	KG
17299	ARRUELA LISA H 5/8 X 3,0 C/47	KG
17309	ARRUELA LISA H 5/8 X 3,0 ZINC	KG
17300	ARRUELA LISA I 3/4 X 3,0 C/38	KG
17724	ARRUELA LISA I 3/4 X 3,0 ZINC	KG
17301	ARRUELA LISA J 7/8 X 3,0 C/26	KG
17725	ARRUELA LISA J 7/8 X 3,0 ZINCAD	KG

CÓD.	DESCRIÇÃO	EMB.
17312	ARRUELA LISA K 1 X 3,0 C/20	KG
17726	ARRUELA LISA K 1 X 3,0 ZINCADA	KG
28593	ARRUELA LISA K 1.1/2	KG
28590	ARRUELA LISA K 1.1/4	KG
28595	ARRUELA LISA K 1.3/4	KG
28591	ARRUELA LISA K 1.3/8	KG
18283	ARRUELA LISA M06 ZINCADA	KG
18284	ARRUELA LISA M08 ZINCADA	KG
18285	ARRUELA LISA M10 ZINCADA	KG
18286	ARRUELA LISA M12 ZINCADA	KG
18287	ARRUELA LISA M14 ZINCADA	KG
18288	ARRUELA LISA M16 ZINCADA	KG

DICA DO REI ARRUELAS LISA

Complemento na aplicação dos fixadores, aumentando o contato da porca ou cabeça do parafuso quando a superfície é irregular. A medida da arruela equivale ao seu diâmetro interno e corresponde a bitola ou diâmetro do respectivo parafuso. Acabamento polido (oleado).

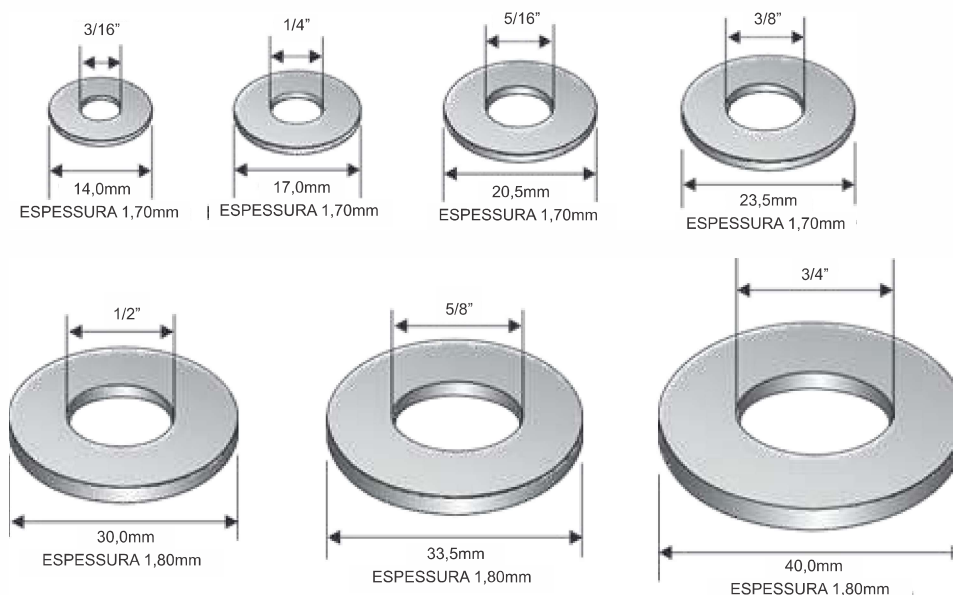

Medida Arruela	Quantidade p/ Kg.
(Pol.)	(Pçs.)
3/16	500
1/4	480
5/16	260
3/8	170
7/16	90
1/2	75
9/16	60
5/8	50
3/4	45
7/8	45
1	28

Obs.: Unidade de venda – kg (embalagem de indústria 30 kg).

Escala 1:1
Tamanho real

ARRUELA P/ PREGO TELHA



CÓD.	DESCRIÇÃO	EMB.
1222	ARRUELA P/TELH PREG PVC C/MIL RISAMP	PT

ARRUELA FUNILEIRO



CÓD.	DESCRIÇÃO	EMB.
17432	ARRUELA FUNIL LISA ACO B 3/16	KG
17433	ARRUELA FUNIL LISA ACO C 1/4	KG
17310	ARRUELA FUNIL LISA ACO C 5/16	KG
17311	ARRUELA FUNIL LISA ACO D 3/8	KG
17434	ARRUELA FUNIL LISA ACO E 1/2	KG

SAIBA MAIS AQUI!

ARRUELA FUNILEIRO

A diferença da arruela funileiro para os outros tipos é que ela é utilizada quando a superfície é irregular, sendo parecida com uma arruela lisa comum, porém possuindo uma aba mais larga que a das arruelas comuns.

ARRUELA PRESSÃO



CÓD.	DESCRIÇÃO	EMB.
1224	ARRUELA PRESSAO A 3/16 C/1000	PT-1-MH
1225	ARRUELA PRESSAO B 1/4 C/1000	PT-1-MH
1226	ARRUELA PRESSAO C 5/16 C/1000	PT
1227	ARRUELA PRESSAO D 3/8 C/1000	PT
1229	ARRUELA PRESSAO E 7/16 C/1000	PT
1230	ARRUELA PRESSAO F 1/2 C/1000	PT

CÓD.	DESCRIÇÃO	EMB.
5713	ARRUELA PRESSAO H 5/8 C/500	PT
5743	ARRUELA PRESSAO I 3/4 C/500	PT
5714	ARRUELA PRESSAO J 7/8 C/250	PT
5715	ARRUELA PRESSAO K 1 C/250	PT
6170	ARRUELA PRESSAO 06MM C/1000	PT-1-MH
6171	ARRUELA PRESSAO 08MM C/1000	PT-1-MH

CÓD.	DESCRIÇÃO	EMB.
6172	ARRUELA PRESSAO 10MM C/1000	PT-1-MH
6173	ARRUELA PRESSAO 12MM C/1000	PT
5716	ARRUELA PRESSAO 14MM C/250	PT
5720	ARRUELA PRESSAO 16MM C/250	PT

BARRA ROSQUEADA



CÓD.	DESCRIÇÃO	EMB.
20206	BARRA ROSQUE 1MT BELENUS B 1/4 C/20	PT-20-PC
20207	BARRA ROSQUE 1MT BELENUS C 5/16 C/20	PT-20-PC
19991	BARRA ROSQUE 1MT BELENUS D 3/8 C/10	PT-10-PC
19992	BARRA ROSQUE 1MT BELENUS E 7/16 C/10	PT-10-PC
20238	BARRA ROSQUE 1MT BELENUS F 1/2 C/10	PT-10-PC
20208	BARRA ROSQUE 1MT BELENUS H 5/8 C/5	PT-5-PC
19994	BARRA ROSQUE 1MT BELENUS I 3/4 C/5	PT-5-PC
19995	BARRA ROSQUE 1MT BELENUS J 7/8 C/5	PT-5-PC
19996	BARRA ROSQUE 1MT BELENUS K 1 C/5	PT-5-PC
1265	BARRA ROSQUE 1MT CISER A 3/16 C/30	PT-30-PC
1266	BARRA ROSQUE 1MT CISER B 1/4 C/20	PT-20-PC
1267	BARRA ROSQUE 1MT CISER C 5/16 C/20	PT-20-PC
1268	BARRA ROSQUE 1MT CISER D 3/8 C/10	PT-10-PC
1269	BARRA ROSQUE 1MT CISER E 7/16 C/10	PT-10-PC

CÓD.	DESCRIÇÃO	EMB.
1270	BARRA ROSQUE 1MT CISER F 1/2 C/10	PT-10-PC
1271	BARRA ROSQUE 1MT CISER H 5/8 C/5	PT-5-PC
1272	BARRA ROSQUE 1MT CISER I 3/4 C/5	PT-5-PC
1273	BARRA ROSQUE 1MT CISER J 7/8 C/5	PT-5-PC
1274	BARRA ROSQUE 1MT CISER K 1 C/5	PT-5-PC
6003	BARRA ROSQUE 1MT CISER MA 06MM C/20	PT-20-PC
6004	BARRA ROSQUE 1MT CISER MA 08MM C/20	PT-20-PC
6006	BARRA ROSQUE 1MT CISER MA 10MM C/10	PT-10-PC
6104	BARRA ROSQUE 1MT CISER MA 12MM C/10	PT-10-PC
6007	BARRA ROSQUE 1MT CISER MA 14MM C/10	PT-10-PC
6008	BARRA ROSQUE 1MT CISER MA 16MM C/05	PT-5-PC
20324	BARRA ROSQUE 1MT ZIN CISER A 3/16 C/30	PT-30-PC
25816	BARRA ROSQUE 1MT ZIN CISER B 1/4 C/20	PT-20-PC
25646	BARRA ROSQUE 1MT ZIN CISER C 5/16C20	PT-20-PC

CÓD.	DESCRIÇÃO	EMB.
25647	BARRA ROSQUE 1MT ZIN CISER D 3/8 C/10	PT-10-PC
25648	BARRA ROSQUE 1MT ZIN CISER E 1/2 C/10	PT-10-PC
15871	BARRA ROSQUE 1MT ZIN CISER H 5/8 C/5	PT-5-PC
15872	BARRA ROSQUE 1MT ZIN CISER I 3/4 C/5	PT-5-PC
15873	BARRA ROSQUE 1MT ZIN CISER J 7/8 C/5	PT-5-PC
15886	BARRA ROSQUE 1MT ZIN CISER K 1 C/5	PT-5-PC
20211	BARRA ROSQUE 1MT ZINC BELENUS B 1/4	PT-20-PC
20212	BARRA ROSQUE 1MT ZINC BELENUS C 5/16	PT-20-PC
20213	BARRA ROSQUE 1MT ZINC BELENUS D 3/8	PT-10-PC
22467	BARRA ROSQUE 1MT ZINC BELENUS F 3/4 C/05	PT-5-PC
25649	BARRA ROSQUE 3MT ZIN CISER C 1/4 C/10	PT-10-PC
25651	BARRA ROSQUE 3MT ZIN CISER D 3/8 C/10	PT-10-PC
15919	BARRA ROSQUE 3MT ZINC BELENUS C 1/4	PT-10-PC
20214	BARRA ROSQUE 3MT ZINC BELENUS C 5/16	PT-10-PC

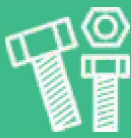

DICA DO REI BARRA ROSQUEADA

As barras rosqueadas são usadas na construção civil, principalmente para sustentação de estruturas metálicas, dutos para sistema de refrigeração, etc. Muitos usuários cortam as barras em comprimentos conforme sua necessidade em substituição a parafusos.

A barra rosqueada é vendida em peças de 1 (um) e 3 (três) metros, variando apenas o tamanho da bitola.

Ex.: 1/4" x 1000mm, 5/16" x 1000mm

Ex.: 1/4" x 1000mm, 5/16" x 1000mm

É fornecida sem acabamento superficial.

Obs.: Srs. Clientes e vendedores, as barras rosqueadas só poderão ser vendidas de acordo com a embalagem.

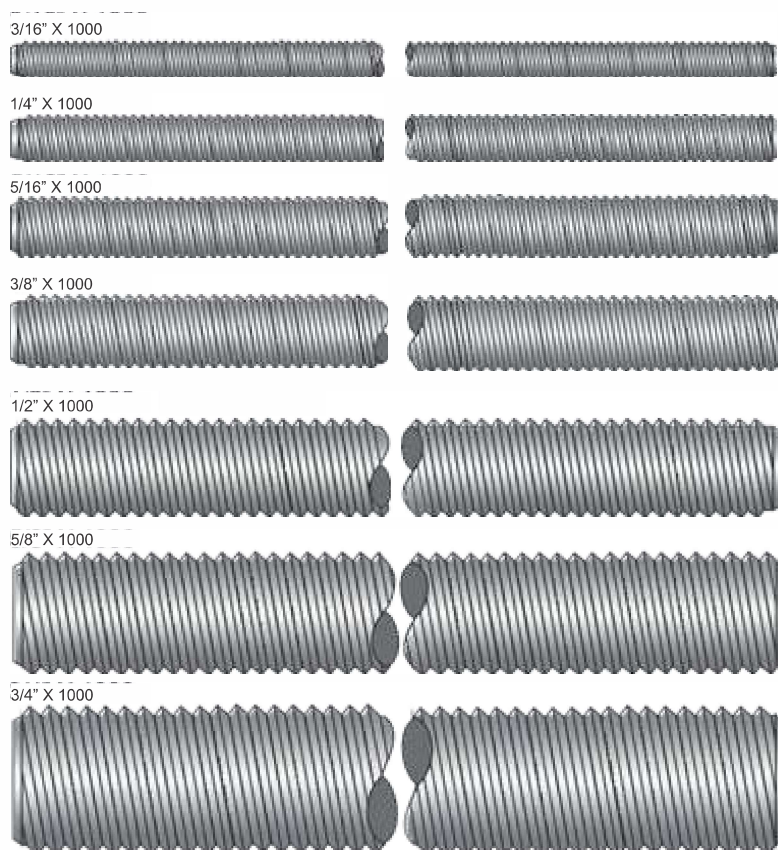

BUCHA C/ ANEL



ECOLIDER



USAF



IVASA



USAF - UNIVERSAL

CÓD.	DESCRIÇÃO	EMB.
29396	BUCHA S-05 C/ANEL C/1000 CZ U-B USAF	PT
12045	BUCHA S-05 C/ANEL C/1000 IVASA	PT
21657	BUCHA S-05 C/ANEL C/1000 ECOLIDER	PT
29397	BUCHA S-06 C/ANEL C/1000 CZ U-B USAF	PT
21391	BUCHA S-06 C/ANEL C/1000 ECOLIDER	PT
10950	BUCHA S-06 C/ANEL C/1000 IVASA	PT
29393	BUCHA S-06 C/ANEL UNIV C/500 CZ U-TB1 USAF	PT
15508	BUCHA S-08 C/ANEL BRANCA C/500 IVASA	PT

CÓD.	DESCRIÇÃO	EMB.
29398	BUCHA S-08 C/ANEL C/1000 CZ U-B USAF	PT
21408	BUCHA S-08 C/ANEL C/1000 ECOLIDER	PT
10951	BUCHA S-08 C/ANEL C/1000 IVASA	PT
29394	BUCHA S-08 C/ANEL UNIV C/100 CZ U-TB1 USAF	PT
15509	BUCHA S-10 C/ANEL BRANCA C/250 IVASA	PT
29399	BUCHA S-10 C/ANEL C/0500 CZ U-B USAF	PT
29395	BUCHA S-10 C/ANEL UNIV C/250 CZ U-TB1 USAF	PT
29400	BUCHA S-12 C/ANEL C/0250 CZ U-B USAF	PT

CÓD.	DESCRIÇÃO	EMB.
10952	BUCHA S-10 C/ANEL C/0500 IVASA	PT
21437	BUCHA S-10 C/ANEL C/500 ECOLIDER	PT
29395	BUCHA S-10 C/ANEL UNIV C/250 CZ U-TB1 USAF	PT
15510	BUCHA S-12 C/ANEL BRANCA C/150 IVASA	PT
29400	BUCHA S-12 C/ANEL C/0250 CZ U-B USAF	PT
12046	BUCHA S-12 C/ANEL C/0250 IVASA	PT
21660	BUCHA S-12 C/ANEL C/250 ECOLIDER	PT

DICA DO REI

BUCHAS

O diâmetro da broca tem que corresponder ao diâmetro da bucha, evitando que a bucha fique "jogando" no buraco. Os parafusos indicados para as buchas são:

Bucha	Parafuso
S-5	3,5x25
S-6	4,2x32
S-7	4,2x32
S-8	4,8x45
S-10	6,3x50
S-10	1/4x50
S-12	5/16x50



Bucha para gesso.

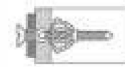

Bucha comum.

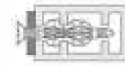

Bucha para tijolo furado.

BUCHA S/ ANEL



CÓD.	DESCRIÇÃO	EMB.
1537	BUCHA S-06 C/1000 IVASA	PT
7514	BUCHA S-07 C/1000 IVASA	PT
1538	BUCHA S-08 C/1000 IVASA	PT
1539	BUCHA S-10 C/0500 IVASA	PT
1540	BUCHA S-12 C/0250 IVASA	PT

BUCHA P/ GESSO



CÓD.	DESCRIÇÃO	EMB.
29404	BUCHA P/GESSO(04-12.5MM)C/50 01 USAF	PT
17017	BUCHA P/GESSO(04-16MM)C/50 01 IVA	PT
29405	BUCHA P/GESSO(12.5-16MM)C/50 02 USAF	PT
17018	BUCHA P/GESSO(15-23MM)C/50 02 IVA	PT
29406	BUCHA P/GESSO(16-25MM)C/50 03 USAF	PT

BUCHA TIJOLO FURADO



CÓD.	DESCRIÇÃO	EMB.
29401	BUCHA S-06 TIJ FURAD C/500 CZ U-FU USAF	PT
10194	BUCHA S-06 TIJ FURAD C/500 IVASA	PT
29402	BUCHA S-08 TIJ FURAD C/100 CZ U-FU USAF	PT
12123	BUCHA S-08 TIJ FURAD C/100 IVASA	PT
29403	BUCHA S-10 TIJ FURAD C/250 CZ U-FU USAF	PT
10201	BUCHA S-10 TIJ FURAD C/250 IVASA	PT

CHUMBADOR



CBN



PBN

CÓD.	DESCRIÇÃO	EMB.
10460	CHUMBADOR CBN 1/4X2 COMP WAL/AN C100	CX-100-PC
15042	CHUMBADOR CBN 1/4X3 COMP WAL/AN C100	CX-100-PC
10461	CHUMBADOR CBN 3/8X2.1/2 COMP W/A C50	CX-50-PC
15043	CHUMBADOR CBN 3/8X3.1/2 COMP W/A C50	CX-50-PC
10462	CHUMBADOR CBN 5/16X2.1/4 COMP A C100	CX-100-PC

CÓD.	DESCRIÇÃO	EMB.
10473	CHUMBADOR PBN 1/2X4 COMP WAL/AN C/50	CX-50-PC
20971	CHUMBADOR PBN 1/2X4.1/2 COMP WAL C50	PT-50-PC
20972	CHUMBADOR PBN 1/2X4.1/4 COMP AN C/25	PT-25-PC
26514	CHUMBADOR PBN 1/2X4.1/4 COMP WA C/50	PT-50-PC
26516	CHUMBADOR PBN 1/4X3.1/4 COMP AN C100	CX-100-PC

CÓD.	DESCRIÇÃO	EMB.
10474	CHUMBADOR PBN 3/8X2.3/4 COMP WA C100	CX-100-PC
10469	CHUMBADOR PBN 3/8X3 COMP WAL/AN C100	CX-100-PC
10470	CHUMBADOR PBN 3/8X3.1/2 COMP AN C/50	CX-50-PC
26517	CHUMBADOR PBN 3/8X3.1/2 COMP WA C100	CX-100-PC
10471	CHUMBADOR PBN 3/8X3.3/4 COMP WA C/50	CX-50-PC



FIXADORES

DICA DO REI CHUMBADORES

Existem diversos tipos de chumbadores, cada qual sendo específico para seu tipo de uso. O modelo mais conhecido de chumbador é o parabol, que no caso é indicado para o uso direto em concreto.

O chumbador é uma espécie de haste rosca constituído de uma porca e/ou rosca e uma “camisa”, muito parecida com uma buxa de parafuso. Esta camisa, ao aplicar torque na porca/parafuso se expande, fixando-a no furo que se pretende fixar algo com o chumbador.

PBN

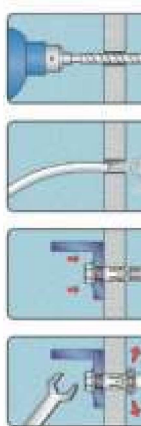

Faça um furo com broca de diâmetro igual ao diâmetro externo do chumbador.

Limpe o furo.

Introduza o chumbador com auxílio de um martelo, deixando os fios de rosca suficientes para a colocação da arruela e da porca.

Rosqueie a porca dando início a expansão da presilha. Ao encontrar resistência, sua fixação estará concluída.

CBN

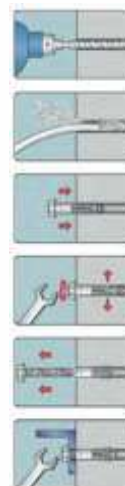

Faça um furo com broca de diâmetro igual ao diâmetro externo do chumbador e comprimento indicado.

Limpe o furo.

Introduza o chumbador montado e ajustado, pronto para a expansão.

A expansão se dará de acordo com o torque que for sendo aplicado ao parafuso.

Retire o parafuso e a arruela.

Posicione o componente a ser fixado. Recoloque o parafuso e a arruela dando o devido aperto.

ESCAPULA



CÓD.	DESCRIÇÃO	EMB.
8527	ESCAPULA P/BUCHA 06 C/100 S/B PARAFI	CT
8528	ESCAPULA P/BUCHA 08 C/100 S/B PARAFI	CT
8530	ESCAPULA P/BUCHA 10 C/100 S/B PARAFI	CT
22686	ESCAPULA P/BUCHA 12 C/100 S/B PARAFI	CT

GANCHO P/ BUCHA



CÓD.	DESCRIÇÃO	EMB.
8521	GANCHO P/BUCHA 06 C/100 S/B PARAFIX	CT
8522	GANCHO P/BUCHA 08 C/100 S/B PARAFIX	CT
8523	GANCHO P/BUCHA 10 C/100 S/B PARAFIX	CT
22685	GANCHO P/BUCHA 12 C/100 S/B PARAFIX	CT

GRAMPO P/ CERCA



CÓD.	DESCRIÇÃO	EMB.
8550	GRAMPO PARA CERCA 1"X09 @#	KG
14481	GRAMPO PARA CERCA 7/8X09 @#	KG
28306	GRAMPO PARA CERCA 7/8X12 @#	KG

HASTE P/ TELHA



Pescador



Reta

CÓD.	DESCRIÇÃO	EMB.
12340	HASTE TELH PESC 1/4X08,5X20 COMPLETA	CT
14794	HASTE TELH PESC 1/4X12,0X20 COMPLETA	CT
22511	HASTE TELH PESC 1/4X15,0X20 COMPLETA	CT

CÓD.	DESCRIÇÃO	EMB.
22510	HASTE TELH 1/4X15 PARAFIX COMPLETA	CT
14792	HASTE TELH 1/4X20 PARAFIX COMPLETA	CT
14793	HASTE TELH 1/4X25 PARAFIX COMPLETA	CT

CÓD.	DESCRIÇÃO	EMB.
12337	HASTE TELH 1/4X30 PARAFIX COMPLETA	CT
12338	HASTE TELH 1/4X35 PARAFIX COMPLETA	CT
12339	HASTE TELH 1/4X40 PARAFIX COMPLETA	CT

PARAFUSO AUTO-ATARRAXANTE - CABEÇA-CHATA



CÓD.	DESCRIÇÃO	EMB.
321	PARAF AA CC 2,2X06,5 PHIL CISER C/500	CX-5-CT
487	PARAF AA CC 2,2X09,5 PHIL CISER C/500	CX-5-CT
395	PARAF AA CC 2,9X09,5 PHIL CISER C/500	CX-5-CT
3633	PARAF AA CC 2,9X13,0 PHIL BELENUS C/500	CX-5-CT
286	PARAF AA CC 2,9X13,0 PHIL CISER C/500	CX-5-CT
24140	PARAF AA CC 2,9X16,0 PHIL BELENUS C/500	CX-5-CT
287	PARAF AA CC 2,9X16,0 PHIL CISER C/500	CX-5-CT
254	PARAF AA CC 2,9X19,0 PHIL CISER C/500	CX-5-CT
258	PARAF AA CC 3,5X09,5 PHIL CISER C/500	CX-5-CT
259	PARAF AA CC 3,5X13,0 PHIL CISER C/500	CX-5-CT
322	PARAF AA CC 3,5X16,0 PHIL CISER C/500	CX-5-CT
24143	PARAF AA CC 3,5X19,0 PHIL BELE C/500	CX-5-CT
255	PARAF AA CC 3,5X19,0 PHIL CISER C/500	CX-5-CT
24145	PARAF AA CC 3,5X25,0 PHIL BELE C/500	CX-5-CT
256	PARAF AA CC 3,5X25,0 PHIL CISER C/500...	CX-5-CT
289	PARAF AA CC 3,9X09,5 PHIL CISER C/500	CX-5-CT
5477	PARAF AA CC 3,9X13,0 PHIL BELENUS C/500	CX-5-CT
290	PARAF AA CC 3,9X13,0 PHIL CISER C/500	CX-5-CT
24306	PARAF AA CC 3,9X16,0 PHIL BELE C/500...	CX-5-CT
324	PARAF AA CC 3,9X16,0 PHIL BELE C/500	CX-5-CT
24147	PARAF AA CC 3,9X19,0 PHIL BELE C/500	CX-5-CT
325	PARAF AA CC 3,9X19,0 PHIL CISER C/500	CX-5-CT
24148	PARAF AA CC 3,9X22,0 PHIL BELE C/500	CX-5-CT
24289	PARAF AA CC 3,9X25,0 PHIL BELE C/500...	CX-5-CT

CÓD.	DESCRIÇÃO	EMB.
327	PARAF AA CC 3,9X25,0 PHIL CISER C/500	CX-5-CT
24307	PARAF AA CC 3,9X32,0 PHIL BELE C/500	CX-5-CT
328	PARAF AA CC 3,9X32,0 PHIL CISER C/500	CX-5-CT
24290	PARAF AA CC 4,2X13,0 PHIL BELE C/500	CX-5-CT
329	PARAF AA CC 4,2X13,0 PHIL CISER C/500	CX-5-CT
24149	PARAF AA CC 4,2X16,0 PHIL BELE C/500	CX-5-CT
330	PARAF AA CC 4,2X16,0 PHIL CISER C/500	CX-5-CT
24439	PARAF AA CC 4,2X19,0 PHIL BELE C/500	CX-5-CT
331	PARAF AA CC 4,2X19,0 PHIL CISER C/500	CX-5-CT
332	PARAF AA CC 4,2X22,0 PHIL CISER C/500	CX-5-CT
24150	PARAF AA CC 4,2X25,0 PHIL BELENUS C/500	CX-5-CT
333	PARAF AA CC 4,2X25,0 PHIL CISER C/500	CX-5-CT
24151	PARAF AA CC 4,2X32,0 PHIL BELE C/500	CX-5-CT
334	PARAF AA CC 4,2X32,0 PHIL CISER C/500	CX-5-CT
24152	PARAF AA CC 4,2X38,0 PHIL BELE C/500	CX-5-CT
491	PARAF AA CC 4,2X38,0 PHIL CISER C/500	CX-5-CT
335	PARAF AA CC 4,8X13,0 PHIL CISER	CX-5-CT
24153	PARAF AA CC 4,8X16,0 PHIL BELENUS C/500	CX-5-CT
336	PARAF AA CC 4,8X16,0 PHIL CISER C/500	CX-5-CT
24440	PARAF AA CC 4,8X19,0 PHIL BELE C/500	CX-5-CT
311	PARAF AA CC 4,8X19,0 PHIL CISER C/500...	CX-5-CT
28262	PARAF AA CC 4,8X22,0 PHIL BELE C/500	CX-5-CT
337	PARAF AA CC 4,8X22,0 PHIL CISER C/500	CX-5-CT
24154	PARAF AA CC 4,8X25,0 PHIL BELE C/500	CX-5-CT

CÓD.	DESCRIÇÃO	EMB.
338	PARAF AA CC 4,8X25,0 PHIL CISER C/500	CX-5-CT
24156	PARAF AA CC 4,8X32,0 PHIL BELENUS C/500	CX-5-CT
339	PARAF AA CC 4,8X32,0 PHIL CISER C/500	CX-5-CT
3322	PARAF AA CC 4,8X38,0 PHIL BELE C/250	CX-2,5-CT
340	PARAF AA CC 4,8X38,0 PHIL CISER C/500	CX-5-CT
24158	PARAF AA CC 4,8X45,0 PHIL BELENUS C/200	CX-2-CT
341	PARAF AA CC 4,8X45,0 PHIL CISER C/200	CX-2-CT
24159	PARAF AA CC 4,8X50,0 PHIL BELE C/200	CX-2-CT
492	PARAF AA CC 4,8X50,0 PHIL CISER C/200	CX-2-CT
24162	PARAF AA CC 5,5X22,0 PHIL BELE C/200	CX-2-CT
24441	PARAF AA CC 5,5X25,0 PHIL BELE C/200	CX-2-CT
292	PARAF AA CC 5,5X32,0 PHIL CISER C/200	CX-2-CT
293	PARAF AA CC 5,5X38,0 PHIL CISER C/200	CX-2-CT
24165	PARAF AA CC 5,5X45,0 PHIL BELE C/200	CX-2-CT
343	PARAF AA CC 5,5X45,0 PHIL CISER C/200	CX-2-CT
24166	PARAF AA CC 5,5X50,0 PHIL BELE C/200	CX-2-CT
294	PARAF AA CC 5,5X50,0 PHIL CISER C/200	CX-2-CT
344	PARAF AA CC 6,3X19,0 PHIL CISER C/200	CX-2-CT
24169	PARAF AA CC 6,3X22,0 PHIL BELE C/200	CX-2-CT
493	PARAF AA CC 6,3X32,0 PHIL CISER C/200	CX-2-CT
347	PARAF AA CC 6,3X45,0 PHIL CISER C/200	CX-2-CT
24173	PARAF AA CC 6,3X50,0 PHIL BELE C/200	CX-2-CT
348	PARAF AA CC 6,3X50,0 PHIL CISER C/200	CX-2-CT

PARAFUSO AUTO-ATARRAXANTE - CABEÇA-PANELA



CÓD.	DESCRIÇÃO	EMB.
296	PARAF AA CP 2,9X06,5 PHIL CISER C/500	CX-5-CT
297	PARAF AA CP 2,9X09,5 PHIL CISER C/500	CX-5-CT
24188	PARAF AA CP 2,9X13,0 PHIL BELE C/500	CX-5-CT
298	PARAF AA CP 2,9X13,0 PHIL CISER C/500	CX-5-CT
24189	PARAF AA CP 2,9X16,0 PHIL BELE C/500	CX-5-CT
382	PARAF AA CP 2,9X16,0 PHIL CISER C/500	CX-5-CT
24190	PARAF AA CP 2,9X19,0 PHIL BELE C/500	CX-5-CT
24196	PARAF AA CP 3,5X09,5 PHIL BELE C/500	CX-5-CT
349	PARAF AA CP 3,5X09,5 PHIL CISER C/500	CX-5-CT
24191	PARAF AA CP 3,5X13,0 PHIL BELE C/500	CX-5-CT
350	PARAF AA CP 3,5X13,0 PHIL CISER C/500	CX-5-CT
24192	PARAF AA CP 3,5X16,0 PHIL BELE C/500	CX-5-CT
351	PARAF AA CP 3,5X16,0 PHIL CISER C/500	CX-5-CT
24193	PARAF AA CP 3,5X19,0 PHIL BELE C/500	CX-5-CT
24194	PARAF AA CP 3,5X22,0 PHIL BELE C/500	CX-5-CT
353	PARAF AA CP 3,5X22,0 PHIL CISER C/500	CX-5-CT
24195	PARAF AA CP 3,5X25,0 PHIL BELE C/500	CX-5-CT
354	PARAF AA CP 3,5X25,0 PHIL CISER C/500	CX-5-CT
24223	PARAF AA CP 3,9X09,5 PHIL BELE C/500	CX-5-CT
355	PARAF AA CP 3,9X09,5 PHIL CISER C/500	CX-5-CT
24230	PARAF AA CP 3,9X13,0 PHIL BELE C/500	CX-5-CT
300	PARAF AA CP 3,9X13,0 PHIL CISER C/500	CX-5-CT
24197	PARAF AA CP 3,9X16,0 PHIL BELE C/500	CX-5-CT
356	PARAF AA CP 3,9X16,0 PHIL CISER C/500	CX-5-CT
24198	PARAF AA CP 3,9X19,0 PHIL BELE C/500	CX-5-CT
357	PARAF AA CP 3,9X19,0 PHIL CISER C/500	CX-5-CT
301	PARAF AA CP 3,9X22,0 PHIL BELE C/500	CX-5-CT
24200	PARAF AA CP 3,9X25,0 PHIL BELE C/500	CX-5-CT
358	PARAF AA CP 3,9X25,0 PHIL CISER C/500	CX-5-CT
24201	PARAF AA CP 3,9X32,0 PHIL BELE C/500	CX-5-CT
359	PARAF AA CP 3,9X32,0 PHIL CISER C/500	CX-5-CT
24206	PARAF AA CP 4,2X09,5 PHIL BELE C/500	CX-5-CT
360	PARAF AA CP 4,2X09,5 PHIL CISER C/500	CX-5-CT
24202	PARAF AA CP 4,2X13,0 PHIL BELE C/500	CX-5-CT

CÓD.	DESCRIÇÃO	EMB.
361	PARAF AA CP 4,2X13,0 PHIL CISER C/500	CX-5-CT
24224	PARAF AA CP 4,2X16,0 PHIL BELE C/500	CX-5-CT
302	PARAF AA CP 4,2X16,0 PHIL CISER C/500	CX-5-CT
24203	PARAF AA CP 4,2X19,0 PHIL BELE C/500	CX-5-CT
362	PARAF AA CP 4,2X19,0 PHIL CISER C/500	CX-5-CT
664	PARAF AA CP 4,2X22,0 PHIL BELE C/500	CX-5-CT
363	PARAF AA CP 4,2X22,0 PHIL CISER C/500	CX-5-CT
24309	PARAF AA CP 4,2X25,0 PHIL BELE C/500	CX-5-CT
364	PARAF AA CP 4,2X25,0 PHIL CISER C/500	CX-5-CT
24204	PARAF AA CP 4,2X32,0 PHIL BELE C/500	CX-5-CT
365	PARAF AA CP 4,2X32,0 PHIL CISER C/500	CX-5-CT
24205	PARAF AA CP 4,2X38,0 PHIL BELE C/500	CX-5-CT
308	PARAF AA CP 4,2X38,0 PHIL CISER C/500	CX-5-CT
24209	PARAF AA CP 4,8X09,5 PHIL BELE C/500	CX-5-CT
303	PARAF AA CP 4,8X09,5 PHIL CISER C/500	CX-5-CT
24231	PARAF AA CP 4,8X13,0 PHIL BELE C/500	CX-5-CT
366	PARAF AA CP 4,8X13,0 PHIL CISER C/500	CX-5-CT
545	PARAF AA CP 4,8X16,0 PHIL BELE C/500	CX-5-CT
367	PARAF AA CP 4,8X16,0 PHIL CISER C/500	CX-5-CT
24207	PARAF AA CP 4,8X19,0 PHIL BELE C/500	CX-5-CT
260	PARAF AA CP 4,8X19,0 PHIL CISER C/500	CX-5-CT
24669	PARAF AA CP 4,8X22,0 PHIL BELE C/500	CX-5-CT
495	PARAF AA CP 4,8X22,0 PHIL CISER C/500	CX-5-CT
24690	PARAF AA CP 4,8X25,0 PHIL BELE C/500	CX-5-CT
304	PARAF AA CP 4,8X25,0 PHIL CISER C/500	CX-5-CT
24208	PARAF AA CP 4,8X32,0 PHIL BELE C/500	CX-5-CT
368	PARAF AA CP 4,8X32,0 PHIL CISER C/500	CX-5-CT
3323	PARAF AA CP 4,8X38,0 PHIL BELE C/250	CX-2,5-CT
369	PARAF AA CP 4,8X38,0 PHIL CISER C/500	CX-5-CT
24591	PARAF AA CP 4,8X45,0 PHIL BELE C/200	CX-2-CT
494	PARAF AA CP 4,8X45,0 PHIL CISER C/200	CX-2-CT
24665	PARAF AA CP 4,8X50,0 PHIL BELE C/200	CX-2-CT
634	PARAF AA CP 4,8X50,0 PHIL CISER C/200...	CX-2-CT
24210	PARAF AA CP 5,5X13,0 PHIL BELE C/500	CX-5-CT

CÓD.	DESCRIÇÃO	EMB.
496	PARAF AA CP 5,5X13,0 PHIL CISER C/500	CX-5-CT
24211	PARAF AA CP 5,5X16,0 PHIL BELE C/200	CX-2-CT
306	PARAF AA CP 5,5X16,0 PHIL CISER C/200	CX-2-CT
24936	PARAF AA CP 5,5X19,0 PHIL BELE C/200	CX-2-CT
257	PARAF AA CP 5,5X19,0 PHIL CISER C/200...	CX-2-CT
24212	PARAF AA CP 5,5X22,0 PHIL BELE C/200	CX-2-CT
534	PARAF AA CP 5,5X22,0 PHIL CISER C/200	CX-2-CT
24213	PARAF AA CP 5,5X25,0 PHIL BELE C/200	CX-2-CT
796	PARAF AA CP 5,5X25,0 PHIL CISER C/200	CX-2-CT
24214	PARAF AA CP 5,5X32,0 PHIL BELE C/200	CX-2-CT
319	PARAF AA CP 5,5X32,0 PHIL CISER C/200	CX-2-CT
28707	PARAF AA CP 5,5X38,0 PHIL BELE C/200	CX-2-CT
370	PARAF AA CP 5,5X38,0 PHIL CISER C/200	CX-2-CT
24293	PARAF AA CP 5,5X45,0 PHIL BELE C/200	CX-2-CT
371	PARAF AA CP 5,5X45,0 PHIL CISER C/200	CX-2-CT
24215	PARAF AA CP 5,5X50,0 PHIL BELE C/200	CX-2-CT
307	PARAF AA CP 5,5X50,0 PHIL CISER C/200	CX-2-CT
24216	PARAF AA CP 6,3X13,0 PHIL BELE C/200	CX-2-CT
24443	PARAF AA CP 6,3X16,0 PHIL BELE C/200	CX-2-CT
373	PARAF AA CP 6,3X16,0 PHIL CISER C/200	CX-2-CT
24217	PARAF AA CP 6,3X19,0 PHIL BELE C/200	CX-2-CT
374	PARAF AA CP 6,3X19,0 PHIL CISER C/200	CX-2-CT
24218	PARAF AA CP 6,3X22,0 PHIL BELE C/200	CX-2-CT
320	PARAF AA CP 6,3X22,0 PHIL CISER C/200...	CX-2-CT
24219	PARAF AA CP 6,3X25,0 PHIL BELE C/200	CX-2-CT
375	PARAF AA CP 6,3X25,0 PHIL CISER C/200	CX-2-CT
24220	PARAF AA CP 6,3X32,0 PHIL BELE C/200	CX-2-CT
376	PARAF AA CP 6,3X32,0 PHIL CISER C/200	CX-2-CT
24221	PARAF AA CP 6,3X38,0 PHIL BELENUS C/200	CX-2-CT
377	PARAF AA CP 6,3X38,0 PHIL CISER C/200	CX-2-CT
378	PARAF AA CP 6,3X45,0 PHIL BELE C/200	CX-2-CT
379	PARAF AA CP 6,3X50,0 PHIL CISER C/200	CX-2-CT



FIXADORES

DICA DO REI

PARAFUSO AUTO ATARRAXANTE

Muito utilizado como buchas de nylon para fixação de acessórios e diversos objetos em paredes de alvenaria, concreto, etc. Utilizado também em móveis tubulares e equipamentos fabricados com chapas metálicas finas.

O comprimento total deste parafuso não inclui a cabeça. É fornecido com acabamento superficial zincado branco.

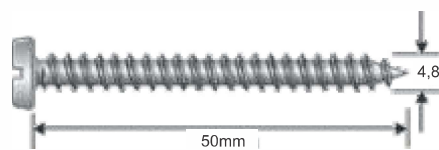

Escala 1:1
Tamanho real



2,9 X 6,5



2,9 X 9,5



2,9 X 13



2,9 X 16



2,9 X 19



3,5 X 9,5



3,5 X 13



3,5 X 16



3,5 X 19



3,5 X 25



3,9 X 9,5

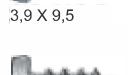

3,5 X 13



3,9 X 16



3,9 X 19



3,9 X 25



3,9 X 32

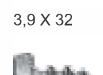

4,2 X 9,5

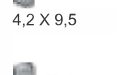

4,2 X 13

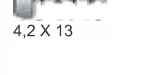

4,2 X 16

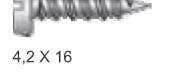

4,2 X 19



4,2 X 25



4,2 X 32



4,2 X 38



4,8 X 9,5

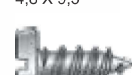

4,8 X 13



4,8 X 16



4,8 X 19



4,8 X 25



4,8 X 32



4,8 X 38



4,8 X 45



4,8 X 50



4,8 X 50



4,8 X 50

CC - Cabeça Chata
CO - Cabeça Oval
CP - Cabeça Panela

PARAFUSO AUTO BROCANTE



Sextavado c/ arruela



Flangelado



Trombeta



Panela

CÓD.	DESCRIÇÃO	EMB.
14588	PARAF AUT FLANG 4,2X13 FORRO CISER	CX-5-CT
15436	PARAF AUT FLANG 4,2X19 FORRO CISER	CX-5-CT
11390	PARAF AUT FLANG 4,2X25 FORRO CISER	CX-5-CT
2280	PARAF AUT FLANG4,2X19P/FORR MULTIFIX ZBC/1000	CX-10-CT
2282	PARAF AUT FLANG4,2X25P/FORR MULTIFIX ZBC/1000	CX-10-CT
23024	PARAF AUT FLANG4,2X45P/FORR ZB C/500	PT-5-CT
5654	PARAF AUT FLAN4,2X13FOR/DRY ZC BELEN C/500	CX-5-CT
2279	PARAF AUT FLAN4,2X13FOR/DRY ZC BC500	CX-10-CT
6214	PARAF AUT FLAN4,2X16FOR/DRY ZC BELEN C/500	CX-5-CT
28168	PARAF AUT FLAN4,2X19FOR/DRY ZC BC500	CX-5-CT
6212	PARAF AUT FLAN4,2X25FOR/DRY ZC BC200	CX-2-CT
6213	PARAF AUT FLAN4,2X45FOR/DRY ZC BC200	CX-2-CT
28170	PARAF AUT G TROM3,5X25FOR/DRY OXB1000	CX-10-CT
21680	PARAF AUT G TROM3,5X25FOR/DRY OXB1000 MULTIFIX	PT-10-CT
3854	PARAF AUT G TROM3,5X35FOR/DRY OX CISER C/1000	CX-10-CT
28171	PARAF AUT G TROM3,5X35FOR/DRY OXB1000	CX-10-CT
2890	PARAF AUT G TROM3,5X35FOR/DRY OXB1000 MULTIFIX	PT-10-CT
3855	PARAF AUT G TROM3,5X45FOR/DRY OX CISER C/1000	CX-10-CT
28173	PARAF AUT G TROM3,5X45FOR/DRY OXB1000	CX-10-CT
8631	PARAF AUT PANEL 3,9X16 PH ZB BEL C/500	PT-5-CT
8251	PARAF AUT PANEL 3,9X19 PH ZB BEL C/500	PT-5-CT

CÓD.	DESCRIÇÃO	EMB.
8257	PARAF AUT PANEL 4,2X13 PH ZB BEL C/500	PT-5-CT
8626	PARAF AUT PANEL 4,2X19 PH ZB BEL C/500	PT-5-CT
865	PARAF AUT SEXAR A 12X1 B TELC200	CX-2-CT
3892	PARAF AUT SEXAR A 12X1 TELHA CISER C/200	CX-2-CT
2563	PARAF AUT SEXAR A 12X1 TELHA C/500 MULTI-FIX	CX-5-CT
27898	PARAF AUT SEXAR A 12X1,1/2 B TELC200	CX-2-CT
21088	PARAF AUT SEXAR A 12X1,1/2 TE C/500	PT-5-CT
3897	PARAF AUT SEXAR A 12X1,1/2 TELHA CISER C/200	CX-2-CT
27899	PARAF AUT SEXAR A 12X2 B TELH C/200	CX-2-CT
3896	PARAF AUT SEXAR A 12X2 TELHA CISER C/200	CX-2-CT
22600	PARAF AUT SEXAR A 12X2 TELHA C/200	PT-2-CT
27900	PARAF AUT SEXAR A 12X2,1/2 B TEC200	CX-2-CT
25635	PARAF AUT SEXAR A 12X2,1/2 TELC/200	CX-2-CT
3895	PARAF AUT SEXAR A 12X2,1/2 TELHA CISER C/200	CX-2-CT
16739	PARAF AUT SEXAR A 12X2,14 TELHA MAD C/200	CX-2-CT
22878	PARAF AUT SEXAR A 12X2,34 TELHA MAD C/200	CX-2-CT
27901	PARAF AUT SEXAR A 12X3 BE TELH C/200	CX-2-CT
2889	PARAF AUT SEXAR A 12X3 TELHA MULTIFIX C/200	PT-2-CT
856	PARAF AUT SEXAR A 12X3,1/2 B TEC200	CX-2-CT
3898	PARAF AUT SEXAR A 12X3,1/2 TELHA CISER C/200	CX-2-CT
22881	PARAF AUT SEXAR A 12X3,1/2 TELHA MAD C/200	CX-1-CT
16151	PARAF AUT SEXAR A 12X3,14 SANDUICHE RUSP C/200	CX-2-CT

CÓD.	DESCRIÇÃO	EMB.
6210	PARAF AUT SEXAR A 12X3/4 B TELC200	CX-2-CT
25633	PARAF AUT SEXAR A 12X3/4 TEL C/500	CX-5-CT
15862	PARAF AUT SEXAR A 12X3/4 TELHA CISER C/200	CX-2-CT
858	PARAF AUT SEXAR A 12X4 BEL TEC200	CX-2-CT
16173	PARAF AUT SEXAR A 12X4 SANDUICHE RUSP C/100	CX-1-CT
3899	PARAF AUT SEXAR A 12X4 TELHA CISER C/200	CX-2-CT
2584	PARAF AUT SEXAR A 12X4 TELHA C/100 MULTIFIX	CX-1-CT
26467	PARAF AUT SEXAR A 12X4 TELHA MAD C/100	CX-1-CT
16741	PARAF AUT SEXAR A 12X4,1/2 TELHA MAD C/100	CX-1-CT
6215	PARAF AUT SEXAR A 12X5 BEL TEC100	CX-1-CT
16227	PARAF AUT SEXAR A 12X5 SANDUICHE RUSP C/100	CX-1-CT
28822	PARAF AUT SEXAR A 12X5 TELHA C/100	CT-1-CT
3893	PARAF AUT SEXAR A 12X7/8 CISER COST C/200	CX-2-CT
6211	PARAF AUT SEXAR A 12X7/8 BELE COST C/200	CX-2-CT
26769	PARAF AUT SEXAR A 12X7/8 COST C/500	PT-5-CT
27902	PARAF AUT SEXAR A 14X3/4 B TELC/200	CX-2-CT
28232	PARAF AUT SEXAR D 14X7/8COSTU BC200	CX-2-CT
28167	PARAF AUT SEXAR J 14X1 TELH B C/200	CX-2-CT
8259	PARAF AUT SEXAR J 14X2 TEL BEL C/200	CX-2-CT

PARAFUSO ALLEN C/ CABEÇA



CÓD.	DESCRIÇÃO	EMB.
27489	PARAF ALLEN 04X010 BELEN C/500	CX-5-CT
27490	PARAF ALLEN 04X012 BELEN C/500	CX-5-CT
27491	PARAF ALLEN 04X016 BELEN C/500	CX-5-CT
27492	PARAF ALLEN 04X020 BELEN C/500	CX-5-CT
27819	PARAF ALLEN 04X025 BELEN C/500	CX-5-CT
27493	PARAF ALLEN 04X030 BELEN C/500	CX-5-CT
27495	PARAF ALLEN 04X035 BELEN C/200	CX-2-CT
27595	PARAF ALLEN 05X010 BELEN C/500	CX-5-CT
27497	PARAF ALLEN 05X012 BELEN C/500	CX-5-CT
27498	PARAF ALLEN 05X016 BELEN C/500	CX-5-CT
27499	PARAF ALLEN 05X020 BELEN C/500	CX-5-CT
28047	PARAF ALLEN 05X025 BELEN C/500	CX-5-CT
27500	PARAF ALLEN 05X030 BELEN C/500	CX-5-CT
27501	PARAF ALLEN 05X035 BELEN C/500	CX-5-CT
27502	PARAF ALLEN 05X040 BELEN C/400	CX-4-CT
6105	PARAF ALLEN 05X050 BELEN C/250	CX-2,5-CT
27504	PARAF ALLEN 06X012 BELEN C/500	CX-5-CT
27505	PARAF ALLEN 06X016 BELEN C/500	CX-5-CT
27507	PARAF ALLEN 06X020 BELEN C/500	CX-5-CT
27508	PARAF ALLEN 06X025 BELEN C/500	CX-5-CT
27509	PARAF ALLEN 06X030 BELEN C/200	CX-2-CT

CÓD.	DESCRIÇÃO	EMB.
27510	PARAF ALLEN 06X035 BELEN C/200	CX-2-CT
27511	PARAF ALLEN 06X040 BELEN C/200	CX-2-CT
27512	PARAF ALLEN 06X045 BELEN C/200	CX-2-CT
27513	PARAF ALLEN 06X050 BELEN C/200	CX-2-CT
27514	PARAF ALLEN 06X060 BELEN C/200	CX-2-CT
27515	PARAF ALLEN 08X016 BELEN C/200	CX-2-CT
27516	PARAF ALLEN 08X020 BELEN C/200	CX-2-CT
27517	PARAF ALLEN 08X025 BELEN C/200	CX-2-CT
27518	PARAF ALLEN 08X030 BELEN C/200	CX-2-CT
27519	PARAF ALLEN 08X035 BELEN C/200	CX-2-CT
27520	PARAF ALLEN 08X040 BELEN C/200	CX-2-CT
3753	PARAF ALLEN 08X050 BELEN C/150	CX1,5-CT
27522	PARAF ALLEN 08X060 BELEN C/100	CX-1-CT
27523	PARAF ALLEN 08X070 BELEN C/100	CX-1-CT
27524	PARAF ALLEN 08X080 BELEN C/100	CX-1-CT
27525	PARAF ALLEN 10X020 BELEN C/200	CX-2-CT
27526	PARAF ALLEN 10X025 BELEN C/200	CX-2-CT
27556	PARAF ALLEN 10X030 BELEN C/100	CX-1-CT
27527	PARAF ALLEN 10X035 BELEN C/100	CX-1-CT
27528	PARAF ALLEN 10X040 BELEN C/100	CX-1-CT
27529	PARAF ALLEN 10X050 BELEN C/100	CX-1-CT

CÓD.	DESCRIÇÃO	EMB.
27531	PARAF ALLEN 10X070 BELEN C/100	CX-1-CT
27532	PARAF ALLEN 10X080 BELEN C/100	CX-1-CT
27534	PARAF ALLEN 10X100 BELEN C/50	CX
27535	PARAF ALLEN 12X030 BELEN C/100	CX-1-CT
27536	PARAF ALLEN 12X035 BELEN C/100	CX-1-CT
27537	PARAF ALLEN 12X040 BELEN C/100	CX-1-CT
4366	PARAF ALLEN 12X040 BELEN C/50	CX
27538	PARAF ALLEN 12X045 BELEN C/100	CX-1-CT
4365	PARAF ALLEN 12X045 BELEN C/50	CX
4912	PARAF ALLEN 12X050 BELEN C/50	CX
27540	PARAF ALLEN 12X060 BELEN C/50	CX
27541	PARAF ALLEN 12X080 BELEN C/50	CX
27543	PARAF ALLEN 12X090 BELEN C/50	CX
27545	PARAF ALLEN 16X045 BELEN C/50	CX
27546	PARAF ALLEN 16X050 BELEN C/50	CX
27547	PARAF ALLEN 16X060 BELEN C/50	CX
27550	PARAF ALLEN 16X080 BELEN C/50	CX

PARAFUSO PONTA AGULHA



Trombeta



Flangelado

CÓD.	DESCRIÇÃO	EMB.
21768	PARAF AG FLAN4,2X13FOR/DRY ZC BC/500	CX-5-CT
3890	PARAF AG FLAN4,2X13FOR/DRY ZC CISER C/500	CX-5-CT
18932	PARAF AG FLAN4,2X13FOR/DRY ZC C/1000	PT-10-CT
22900	PARAF AG FLAN4,2X19FOR/DRY ZB C/1000	CX-10-CT
22914	PARAF AG FLAN4,2X25FOR/DRY ZB C/500	CX-5-CT

CÓD.	DESCRIÇÃO	EMB.
3889	PARAF AG TROM3,5X25FOR/DRY OX CISER C/1000	CX-10-CT
20234	PARAF AG TROM3,5X25FOR/DRY OX C/1000	CX-10-CT
28234	PARAF AG TROM3,5X25FOR/DRY OXBC/1000	CX-10-CT
3840	PARAF AG TROM3,5X35FOR/DRY OX CISER C/1000	CX-10-CT
21439	PARAF AG TROM3,5X35FOR/DRY OX C/1000	CX-10-CT

CÓD.	DESCRIÇÃO	EMB.
28233	PARAF AG TROM3,5X35FOR/DRY OXBC/1000	CX-10-CT
3853	PARAF AG TROM3,5X45FOR/DRY OX CISER C/1000	CX-10-CT
28235	PARAF AG TROM3,5X45FOR/DRY OXBC/1000	CX-10-CT



FIXADORES

PARAFUSO MÓVEIS



Zincado



Bicromatizado

CÓD.	DESCRIÇÃO	EMB.
25696	PARAF MOV 4,8X30 TAMP PHIL RP C/200	CX-2-CT
37	PARAF MOV 4,8X40 TAMP PHIL BELENUS ZI	CX-5-CT
38	PARAF MOV 4,8X50 TAMP PHIL BELENUS ZI	CX-5-CT
12410	PARAF MOV 4,8X50 TAMP PHIL RP BIC C/200	CX-2-CT
25697	PARAF MOV 4,8X50 TAMP PHIL RP C/200	CX-2-CT
128	PARAF MOV 4,8X55 TAMP PHIL BELENUS ZI	CT-1-CT

CÓD.	DESCRIÇÃO	EMB.
12413	PARAF MOV 4,8X65 TAMP PHIL RP BIC C/100	CT
25698	PARAF MOV 4,8X65 TAMP PHIL RP C/100	CT
39	PARAF MOV 4,8X65 TAMP PHIL BELENUS ZI C/1000	CX-10-CT
26626	PARAF MOV 4,8X75 TAMP PHIL RP BIC C/100	CT
7522	PARAF MOV 4,8X75 TAMP PHIL RP C/100	CT
5550	PARAF MOV 5,5X50 TAMP PHIL BELENUS ZI	CX-1-CT

CÓD.	DESCRIÇÃO	EMB.
12418	PARAF MOV 5,5X50 TAMP PHIL RP BIC C/100	CT
25701	PARAF MOV 5,5X50 TAMP PHIL RP C/100	CT
52	PARAF MOV 5,5X65 TAMP PHIL BELENUS ZI	CX-1-CT
12419	PARAF MOV 5,5X65 TAMP PHIL RP BIC C/100	CT
25700	PARAF MOV 5,5X65 TAMP PHIL RP C/100	CT
41	PARAF MOV 5,5X75 TAMP PHIL BELENUS ZI C/100	CX-1-CT

PARAFUSO ROSCA MÁQUINA - CABEÇA CHATA



CÓD.	DESCRIÇÃO	EMB.
12902	PARAF R MAQ CC DD 3/16X1/2 BELEC/500	CX-5-CT
16905	PARAF R MAQ CC DH 3/16X1 BELEN C/500	CX-5-CT
12905	PARAF R MAQ CC DJ 3/16X1.1/2 BEC/200	CX-2-CT

CÓD.	DESCRIÇÃO	EMB.
17089	PARAF R MAQ CC DL 3/16X2 BELEN C/100	CX-1-CT
24000	PARAF R MAQ CC DN 3/16X2.1/2 BEC/100	CX-1-CT
23302	PARAF R MAQ CC DP 3/16X3 BELENUC/100	CX-1-CT

CÓD.	DESCRIÇÃO	EMB.
12908	PARAF R MAQ CC EF 1/4X1 BELE/SOC/200	CX-2-CT
12910	PARAF R MAQ CC EJ 1/4X2 BEL/SOFC/100	CX-1-CT
12911	PARAF R MAQ CC EL 1/4X2.1/2 BELC/100	CX-1-CT

BUCHAS DE FIXAÇÃO

BUCHAS DE FIXAÇÃO



PARAFUSO ROSCA MÁQUINA - CILÍNDRICO

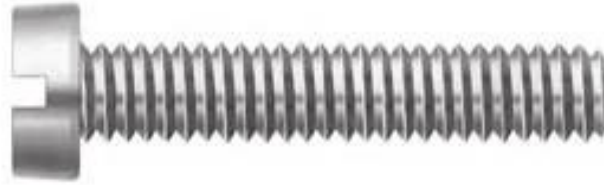

CÓD.	DESCRIÇÃO	EMB.
28679	PARAF R MAQ CIL 04X008 CISER C/500	CX-5-CT
17684	PARAF R MAQ CIL 04X010 CISER C/500	CX-5-CT
21521	PARAF R MAQ CIL 04X012 CISER C/500	CX-5-CT
16398	PARAF R MAQ CIL 04X020 BELENUS C/500	CX-5-CT
17685	PARAF R MAQ CIL 04X020 CISER C/500	CX-5-CT
16393	PARAF R MAQ CIL 04X025 BELENUS C/500	CX-5-CT
17686	PARAF R MAQ CIL 04X025 CISER C/500	CX-5-CT
24001	PARAF R MAQ CIL 04X030 BELENUS C/500	CX-5-CT
21522	PARAF R MAQ CIL 04X030 CISER C/500	CX-5-CT
16550	PARAF R MAQ CIL 05X012 BELEN/SOC/500	CX-5-CT
17687	PARAF R MAQ CIL 05X012 CISER C/500	CX-5-CT
16551	PARAF R MAQ CIL 05X016 BELENUS C/500	CX-5-CT
17688	PARAF R MAQ CIL 05X016 CISER C/500	CX-5-CT

CÓD.	DESCRIÇÃO	EMB.
16397	PARAF R MAQ CIL 05X020 BELENUS C/200	CX-2-CT
17689	PARAF R MAQ CIL 05X020 CISER C/200	CX-2-CT
16404	PARAF R MAQ CIL 05X025 BELENUS C/200	CX-2-CT
17690	PARAF R MAQ CIL 05X025 CISER C/200	CX-2-CT
16402	PARAF R MAQ CIL 05X030 BELENUS C/200	CX-2-CT
17691	PARAF R MAQ CIL 05X030 CISER C/200	CX-2-CT
14633	PARAF R MAQ CIL 05X040 CISER C/200	CX-2-CT
14634	PARAF R MAQ CIL 05X050 CISER C/200	CX-2-CT
27380	PARAF R MAQ CIL 06X010 CISER C/200	CX-2-CT
17692	PARAF R MAQ CIL 06X012 CISER C/200	CX-2-CT
16401	PARAF R MAQ CIL 06X016 BELENUS C/200	CX-2-CT
17693	PARAF R MAQ CIL 06X016 CISER C/200	CX-2-CT
16396	PARAF R MAQ CIL 06X020 BELE/SOFC/200	CX-2-CT

CÓD.	DESCRIÇÃO	EMB.
17694	PARAF R MAQ CIL 06X020 CISER C/200	CX-2-CT
16394	PARAF R MAQ CIL 06X025 BELENUS C/200	CX-2-CT
17695	PARAF R MAQ CIL 06X025 CISER C/200	CX-2-CT
16549	PARAF R MAQ CIL 06X030 BELEN/SOC/200	CX-2-CT
17696	PARAF R MAQ CIL 06X030 CISER C/200	CX-2-CT
16399	PARAF R MAQ CIL 06X040 BELENUS C/100	CX-1-CT
16403	PARAF R MAQ CIL 06X050 BELENUS C/100	CX-1-CT
17698	PARAF R MAQ CIL 06X050 CISER C/100	CX-1-CT
21526	PARAF R MAQ CIL 08X020 CISER C/100	CX-1-CT
21528	PARAF R MAQ CIL 08X030 CISER C/100	CX-1-CT
21529	PARAF R MAQ CIL 08X040 CISER C/100	CX-1-CT
21530	PARAF R MAQ CIL 08X050 CISER C/100	CX-1-CT

PARAFUSO ROSCA MÁQUINA - CABEÇA PANELA PHILIPS



CÓD.	DESCRIÇÃO	EMB.
4033	PARAF R MAQ CP BE 1/8X5/8 PHIL CISERC/500	CX-5-CT
4036	PARAF R MAQ CP BH 1/8X1 PHIL CISER C/500	CX-5-CT
4038	PARAF R MAQ CP BJ 1/8X1, 1/2 PHIL CISC/200	CX-2-CT
11844	PARAF R MAQ CP BK 1/8X2 PHIL CISER C/200	CX-2-CT
4039	PARAF R MAQ CP CA 5/32X1/4 PHIL CISEC/500	CX-5-CT
4043	PARAF R MAQ CP CE 5/32X5/8 PHIL CISEC/500	CX-5-CT
4044	PARAF R MAQ CP CF 5/32X3/4 PHIL CISER	CX-5-CT
4047	PARAF R MAQ CP CI 5/32X1,1/4 PHIL CISER C/200	CX-2-CT

CÓD.	DESCRIÇÃO	EMB.
4048	PARAF R MAQ CP CJ 5/32X1,1/2 PHIL CISER C/200	CX-2-CT
4049	PARAF R MAQ CP CK 5/32X1,3/4 PHIL CISER C/200	CX-2-CT
4056	PARAF R MAQ CP DF 3/16X3/4 PHIL CISEC/500	CX-5-CT
4057	PARAF R MAQ CP DG 3/16X7/8 PHIL CISER C/500	CX-5-CT
4058	PARAF R MAQ CP DH 3/16X1 PHIL CISER C/500	CX-5-CT
4059	PARAF R MAQ CP DI 3/16X1, 1/4 PHIL CISER C/200	CX-2-CT
4060	PARAF R MAQ CP DJ 3/16X1,1/2 PHIL CISC/200	CX-2-CT
4068	PARAF R MAQ CP DR 3/16X4 PHIL CISER C/100	CX-1-CT

CÓD.	DESCRIÇÃO	EMB.
4069	PARAF R MAQ CP EA 1/4X3/8 PHIL CISER C/500	CX-5-CT
4071	PARAF R MAQ CP EC 1/4X5/8 PHIL CISER C/200	CX-2-CT
4072	PARAF R MAQ CP ED 1/4X3/4 PHIL CISER C/200	CX-2-CT
4074	PARAF R MAQ CP EF 1/4X1 PHIL CISER C/200	CX-2-CT
4078	PARAF R MAQ CP EJ 1/4X2 PHIL CISER C/100	CX-1-CT

PARAFUSO CAMA



Bicromatizado Fendado



Zincado Furado



Polido Furado

CÓD.	DESCRIÇÃO	EMB.
14453	PARAF CAMA FEND BIC 1/4X090 CISER	CT
14490	PARAF CAMA FEND BIC 1/4X100 CISER	CT
8250	PARAF CAMA FEND BIC 1/4X110 CISER C/100	CT
18062	PARAF CAMA FEND BIC 1/4X120 CISER	CT
11336	PARAF CAMA FEND BIC 5/16X100 CISER	CT
11220	PARAF CAMA FEND BIC 5/16X110 CISER	CT

CÓD.	DESCRIÇÃO	EMB.
11221	PARAF CAMA FEND BIC 5/16X120 CISER	CT
12065	PARAF CAMA FEND BIC 5/16X130 CISER	CT
6477	PARAF CAMA POL 5/16X100 CISER C/100	CT
6478	PARAF CAMA POL 5/16X110 CISER C/100	CX-1-CT
6479	PARAF CAMA POL 5/16X120 CISER C/100	CX-1-CT
6076	PARAF CAMA POL 5/16X140 CISER C/100	CT

CÓD.	DESCRIÇÃO	EMB.
3742	PARAF CAMA ZINC 5/16X100 CISER	CX-1-CT
3743	PARAF CAMA ZINC 5/16X110 CISER C/100	CX-1-CT
3744	PARAF CAMA ZINC 5/16X120 CISER	CT
5185	PARAF CAMA ZINC 5/16X140 CISER	CT



DICA DO REI

PARAFUSO CAMA

Escala 1:1
Tamanho real

Utilizado na fixação de móveis (camas, beliches, etc).
O comprimento do parafuso inclui a cabeça, uma vez que ela fica embutida na montagem. É fornecido sem acabamento superficial, com porca retangular e arruela lisa.

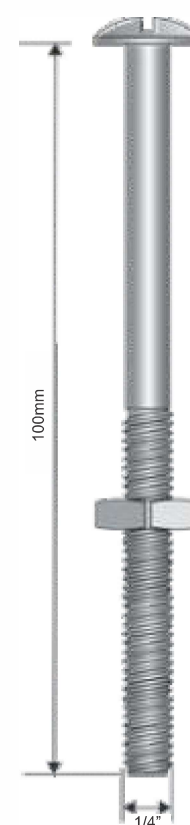
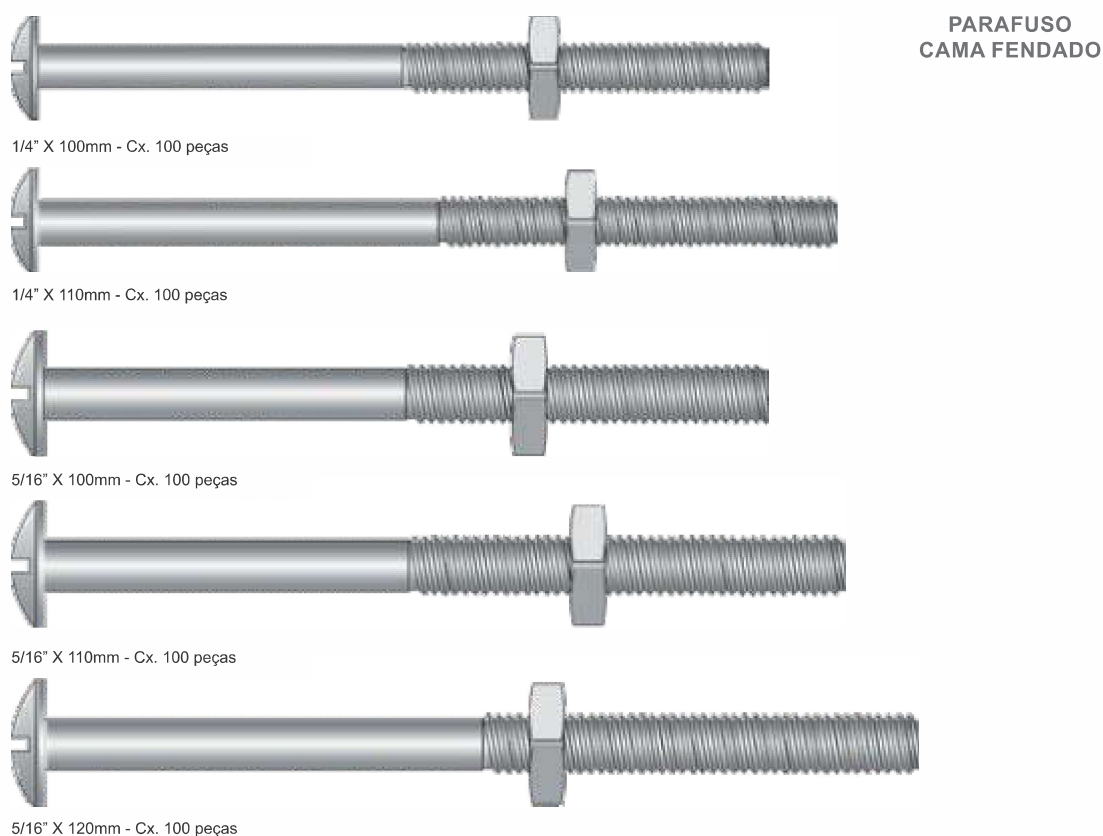
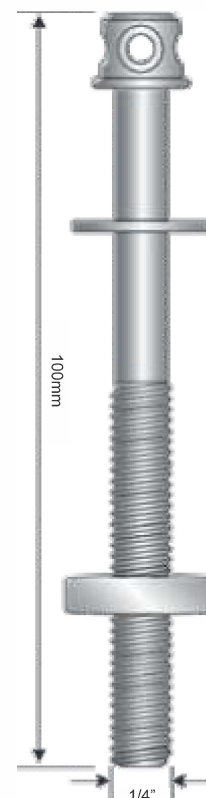
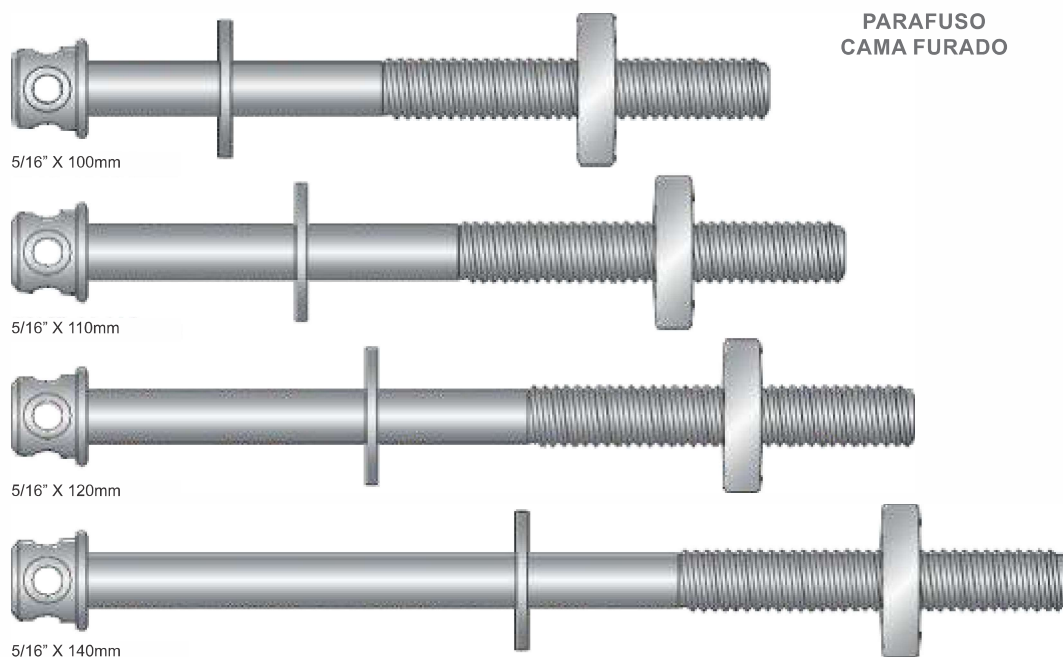

PARAFUSO ROSCA MÁQUINA - CABEÇA REDONDA



CÓD.	DESCRIÇÃO	EMB.
5375	PARAF R MAQ CR IE 1/8X5/8 CISE C/500	CX-5-CT
12912	PARAF R MAQ CR IF 1/8X3/4 BELENUS	CX-5-CT
5376	PARAF R MAQ CR IF 1/8X3/4 CISE C/500	CX-5-CT
13177	PARAF R MAQ CR IH 1/8X1 BEL/SOFC/500	CX-5-CT
5378	PARAF R MAQ CR IH 1/8X1 CISOER C/500	CX-5-CT
12913	PARAF R MAQ CR IJ 1/8X1.1/2 BE C/200	CX-5-CT
5380	PARAF R MAQ CR IJ 1/8X1.1/2 CI C/200	CX-5-CT
24003	PARAF R MAQ CR IL 1/8X2 BELENUSC/200	CX-5-CT
6101	PARAF R MAQ CR IL 1/8X2 CISOER C/200	CX-5-CT
5381	PARAF R MAQ CR JA 5/32X1/4 CIS C/500	CX-5-CT
13180	PARAF R MAQ CR JC 5/32X3/8 BELENUS C/500	CX-5-CT
5383	PARAF R MAQ CR JC 5/32X3/8 CIS C/500	CX-5-CT
5384	PARAF R MAQ CR JD 5/32X1/2 CIS C/500	CX-5-CT
13181	PARAF R MAQ CR JE 5/32X5/8 BELENUS C/500	CX-5-CT
5385	PARAF R MAQ CR JE 5/32X5/8 CIS C/500	CX-5-CT
12916	PARAF R MAQ CR JF 5/32X3/4 BELEC/500	CX-5-CT
5386	PARAF R MAQ CR JF 5/32X3/4 CIS C/500	CX-5-CT
27408	PARAF R MAQ CR JG 5/32X7/8 BELEC/500	CX-5-CT
5387	PARAF R MAQ CR JG 5/32X7/8 CIS C/500	CX-5-CT
16945	PARAF R MAQ CR JH 5/32X1 BELENUS C/500	CX-5-CT
5388	PARAF R MAQ CR JH 5/32X1 CISOER C/500	CX-5-CT
13182	PARAF R MAQ CR JI 5/32X1.1/4 BEC/200	CX-2-CT
12918	PARAF R MAQ CR JJ 5/32X1.1/2 BEC/200	CX-2-CT
5390	PARAF R MAQ CR JJ 5/32X1.1/2 C/200	CX-2-CT
5391	PARAF R MAQ CR JL 5/32X1.3/4 C C/200	CX-2-CT
12920	PARAF R MAQ CR JM 5/32X2 BELENUS C/200	CX-2-CT
5392	PARAF R MAQ CR JM 5/32X2 CISOER C/200	CX-2-CT
19616	PARAF R MAQ CR LA 3/16X1/4 BEL C/500	CX-5-CT

CÓD.	DESCRIÇÃO	EMB.
12921	PARAF R MAQ CR LC 3/16X3/8 BEL C/500	CX-5-CT
12975	PARAF R MAQ CR LD 3/16X1/2 BEL C/500	CX-5-CT
5396	PARAF R MAQ CR LD 3/16X1/2 CIS C/500	CX-5-CT
12922	PARAF R MAQ CR LE 3/16X5/8 BEL C/500	CX-5-CT
5397	PARAF R MAQ CR LE 3/16X5/8 CIS C/500	CX-5-CT
12923	PARAF R MAQ CR LF 3/16X3/4 BEL C/500	CX-5-CT
5398	PARAF R MAQ CR LF 3/16X3/4 CIS C/500	CX-5-CT
12924	PARAF R MAQ CR LG 3/16X7/8 BEL C/500	CX-5-CT
5399	PARAF R MAQ CR LG 3/16X7/8 CIS C/500	CX-5-CT
16947	PARAF R MAQ CR LH 3/16X1 BELEN C/500	CX-5-CT
5400	PARAF R MAQ CR LH 3/16X1 CISOER C/500	CX-5-CT
12926	PARAF R MAQ CR LI 3/16X1.1/4 BEC/200	CX-2-CT
5401	PARAF R MAQ CR LI 3/16X1.1/4 C/200	CX-2-CT
12974	PARAF R MAQ CR LJ 3/16X1.1/2 BEC/200	CX-2-CT
5402	PARAF R MAQ CR LJ 3/16X1.1/2 C/200	CX-2-CT
12927	PARAF R MAQ CR LL 3/16X1.3/4 BEC/200	CX-2-CT
5403	PARAF R MAQ CR LL 3/16X1.3/4 C/200	CX-2-CT
17278	PARAF R MAQ CR LM 3/16X2 BELE/SOC/100	CX-1-CT
5404	PARAF R MAQ CR LM 3/16X2 CISOER C/100	CX-1-CT
16946	PARAF R MAQ CR LO 3/16X2.1/2 BEC/100	CX-1-CT
5406	PARAF R MAQ CR LO 3/16X2.1/2 C/100	CX-1-CT
12929	PARAF R MAQ CR LP 3/16X3 BELEN C/100	CX-1-CT
23028	PARAF R MAQ CR LR 3/16X3.1/2 BEC/100	CX-1-CT
23029	PARAF R MAQ CR LS 3/16X4 BELEN C/100	CX-1-CT
5410	PARAF R MAQ CR LS 3/16X4 CISOER C/100	CX-1-CT
5411	PARAF R MAQ CR MA 1/4X3/8 CISE C/500	CX-5-CT
13099	PARAF R MAQ CR MB 1/4X1/2 BELE C/500	CX-5-CT
5412	PARAF R MAQ CR MB 1/4X1/2 CISE C/500	CX-5-CT

CÓD.	DESCRIÇÃO	EMB.
12932	PARAF R MAQ CR MC 1/4X5/8 BELE C/200	CX-2-CT
5413	PARAF R MAQ CR MC 1/4X5/8 CISE C/200	CX-2-CT
12933	PARAF R MAQ CR MD 1/4X3/4 BELE C/200	CX-2-CT
5414	PARAF R MAQ CR MD 1/4X3/4 CISE C/200	CX-2-CT
12973	PARAF R MAQ CR ME 1/4X7/8 BELE C/200	CX-2-CT
12934	PARAF R MAQ CR MF 1/4X1 BELE/SOC/200	CX-2-CT
5416	PARAF R MAQ CR MF 1/4X1 CISOER C/200	CX-2-CT
12935	PARAF R MAQ CR MG 1/4X1.1/4 BE C/200	CX-2-CT
5417	PARAF R MAQ CR MG 1/4X1.1/4 CI C/200	CX-2-CT
12936	PARAF R MAQ CR MH 1/4X1.1/2 BELC/100	CX-1-CT
5418	PARAF R MAQ CR MH 1/4X1.1/2 CI C/100	CX-1-CT
5419	PARAF R MAQ CR MI 1/4X1.3/4 CI C/100	CX-1-CT
12938	PARAF R MAQ CR MJ 1/4X2 BELE/SOC/100	CX-1-CT
5420	PARAF R MAQ CR MJ 1/4X2 CISOER C/100	CX-1-CT
12939	PARAF R MAQ CR MM 1/4X2.1/2 BELC/100	CX-1-CT
12940	PARAF R MAQ CR MO 1/4X3 BEL/SOFC/100	CX-1-CT
5424	PARAF R MAQ CR MO 1/4X3 CISOER C/100	CX-1-CT
23307	PARAF R MAQ CR MP 1/4X3.1/2 BELC/100	CT
12941	PARAF R MAQ CR MQ 1/4X4 BELE/SOFC/100	CX-1-CT
5426	PARAF R MAQ CR MQ 1/4X4 CISOER C/100	CX-1-CT
6871	PARAF R MAQ CR MS 5/16X1.1/2 C C/100	CX-1-CT
11273	PARAF R MAQ CR MS 5/16X3 CISOER C/100	CX-1-CT
5769	PARAF R MAQ CR NS 5/16X1.1/4 CISOER C/100	CX-1-CT

PARAFUSO CHIP



Chata



Flangeado



Panela

CÓD.	DESCRIÇÃO	EMB.
13134	PARAF CHIP CHATA 3,0X10 BELENUS C/1000	CX-10-CT
9984	PARAF CHIP CHATA 3,0X10 CISOER C/1000...	CX-10-CT
13135	PARAF CHIP CHATA 3,0X12 BELENUS C/1000	CX-10-CT
28936	PARAF CHIP CHATA 3,0X12 CISOER C/1000...	CX-10-CT
12950	PARAF CHIP CHATA 3,0X14 BELENUS C/1000	CX-10-CT
9986	PARAF CHIP CHATA 3,0X14 CISOER C/1000...	CX-10-CT
12951	PARAF CHIP CHATA 3,0X16 BELENUS C/1000	CX-10-CT
9987	PARAF CHIP CHATA 3,0X16 CISOER C/1000...	CX-10-CT
13141	PARAF CHIP CHATA 3,0X20 BELENUS C/1000	CX-10-CT
29091	PARAF CHIP CHATA 3,0X20 CISOER C/1000...	CX-10-CT
2291	PARAF CHIP CHATA 3,0X22 BELENUS C/500	CX-5-CT
9988	PARAF CHIP CHATA 3,0X22 CISOER C/1000...	CX-10-CT
13143	PARAF CHIP CHATA 3,0X25 BELENUS C/500	CX-5-CT
28864	PARAF CHIP CHATA 3,0X25 CISOER C/1000...	CX-10-CT
12952	PARAF CHIP CHATA 3,0X30 BELENUS C/500	CX-5-CT
9990	PARAF CHIP CHATA 3,0X30 CISOER C/1000	CX-10-CT
13145	PARAF CHIP CHATA 3,5X14 BELENUS C/1000	CX-10-CT
28865	PARAF CHIP CHATA 3,5X14 CISOER C/1000	CX-10-CT
12953	PARAF CHIP CHATA 3,5X16 BELENUS C/500	CX-5-CT
28937	PARAF CHIP CHATA 3,5X16 CISOER C/1000	CX-10-CT
12954	PARAF CHIP CHATA 3,5X20 BELENUS C/500	CX-5-CT
29198	PARAF CHIP CHATA 3,5X20 CISOER C/1000...	CX-10-CT
13146	PARAF CHIP CHATA 3,5X22 BELENUS C/500	CX-5-CT
10014	PARAF CHIP CHATA 3,5X22 CISOER C/1000...	CX-10-CT
12955	PARAF CHIP CHATA 3,5X25 BELENUS C/500	CX-5-CT
28868	PARAF CHIP CHATA 3,5X25 CISOER C/1000...	CX-10-CT
12956	PARAF CHIP CHATA 3,5X30 BELENUS C/500	CX-5-CT
29006	PARAF CHIP CHATA 3,5X30 CISOER C/1000	CX-10-CT
12957	PARAF CHIP CHATA 3,5X35 BELENUS C/500	CX-5-CT
28869	PARAF CHIP CHATA 3,5X35 CISOER C/500	CX-5-CT
12958	PARAF CHIP CHATA 3,5X40 BELENUS C/500	CX-5-CT
28947	PARAF CHIP CHATA 3,5X40 CISOER C/500	CX-5-CT
28181	PARAF CHIP CHATA 4,0X12 BELENUS C/500	CX-5-CT
29092	PARAF CHIP CHATA 4,0X12 CISOER C/1000...	CX-10-CT
13147	PARAF CHIP CHATA 4,0X14 BELENUS C/500	CX-5-CT
28870	PARAF CHIP CHATA 4,0X14 CISOER C/1000	CX-10-CT
12959	PARAF CHIP CHATA 4,0X16 BELENUS C/500	CX-5-CT
29009	PARAF CHIP CHATA 4,0X16 CISOER C/1000	CX-10-CT
12960	PARAF CHIP CHATA 4,0X20 BELENUS C/500	CX-5-CT
10019	PARAF CHIP CHATA 4,0X20 CISOER C/1000	CX-10-CT
12961	PARAF CHIP CHATA 4,0X22 BELENUS C/500	CX-5-CT
282	PARAF CHIP CHATA 4,0X22 CISOER C/1000...	CX-10-CT
12962	PARAF CHIP CHATA 4,0X25 BELENUS C/500	CX-5-CT

CÓD.	DESCRIÇÃO	EMB.
28939	PARAF CHIP CHATA 4,0X25 CISOER C/1000...	CX-10-CT
12963	PARAF CHIP CHATA 4,0X30 BELENUS C/500	CX-5-CT
29094	PARAF CHIP CHATA 4,0X30 CISOER C/500	CX-5-CT
12964	PARAF CHIP CHATA 4,0X35 BELENUS C/500	CX-5-CT
28871	PARAF CHIP CHATA 4,0X35 CISOER C/500	CX-5-CT
12965	PARAF CHIP CHATA 4,0X40 BELENUS/SOFI	CX-5-CT
28872	PARAF CHIP CHATA 4,0X40 CISOER C/500	CX-5-CT
16954	PARAF CHIP CHATA 4,0X45 BELENUS C/500	CX-5-CT
28873	PARAF CHIP CHATA 4,0X45 CISOER C/300	CX-3-CT
16904	PARAF CHIP CHATA 4,0X50 BELENUS C/500	CX-5-CT
28940	PARAF CHIP CHATA 4,0X50 CISOER C/300...	CX-3-CT
17375	PARAF CHIP CHATA 4,0X50 BELENUS C/500	CX-5-CT
10024	PARAF CHIP CHATA 4,5X20 CISOER C/500	CX-5-CT
13149	PARAF CHIP CHATA 4,5X22 BELENUS C/500	CX-5-CT
28874	PARAF CHIP CHATA 4,5X22 CISOER C/500...	CX-5-CT
12967	PARAF CHIP CHATA 4,5X25 BELENUS C/500	CX-5-CT
28875	PARAF CHIP CHATA 4,5X25 CISOER C/500	CX-5-CT
12976	PARAF CHIP CHATA 4,5X30 BELENUS C/500	CX-5-CT
29199	PARAF CHIP CHATA 4,5X30 CISOER C/500	CX-5-CT
13150	PARAF CHIP CHATA 4,5X35 BELENUS C/500	CX-5-CT
28876	PARAF CHIP CHATA 4,5X35 CISOER C/500	CX-5-CT
13152	PARAF CHIP CHATA 4,5X40 BELENUS C/500	CX-5-CT
28878	PARAF CHIP CHATA 4,5X40 CISOER C/300...	CX-3-CT
13098	PARAF CHIP CHATA 4,5X45 BELENUS C/500	CX-5-CT
28879	PARAF CHIP CHATA 4,5X45 CISOER C/300...	CX-3-CT
12968	PARAF CHIP CHATA 4,5X50 BELENUS C/500	CX-5-CT
28946	PARAF CHIP CHATA 4,5X50 CISOER C/300	CX-3-CT
12969	PARAF CHIP CHATA 4,5X60 BELENUS C/200	CX-2-CT
28881	PARAF CHIP CHATA 4,5X60 CISOER C/300...	CX-3-CT
13153	PARAF CHIP CHATA 5,0X25 BELENUS C/500	CX-5-CT
24	PARAF CHIP CHATA 5,0X25 CISOER C/500	CX-5-CT
13154	PARAF CHIP CHATA 5,0X30 BELENUS C/500	CX-5-CT
28945	PARAF CHIP CHATA 5,0X30 CISOER C/500	CX-5-CT
19777	PARAF CHIP CHATA 5,0X35 BELENUS C/500	CX-5-CT
28882	PARAF CHIP CHATA 5,0X35 CISOER C/300...	CX-3-CT
19786	PARAF CHIP CHATA 5,0X40 BELENUS C/500	CX-5-CT
28941	PARAF CHIP CHATA 5,0X40 CISOER C/300...	CX-3-CT
13155	PARAF CHIP CHATA 5,0X45 BELENUS C/200	CX-2-CT
28883	PARAF CHIP CHATA 5,0X45 CISOER C/300	CX-3-CT
12970	PARAF CHIP CHATA 5,0X50 BELENUS C/200	CX-2-CT
28884	PARAF CHIP CHATA 5,0X50 CISOER C/300...	CX-3-CT
12971	PARAF CHIP CHATA 5,0X60 BELENUS C/200	CX-2-CT
29095	PARAF CHIP CHATA 5,0X60 CISOER C/200...	CX-2-CT

CÓD.	DESCRIÇÃO	EMB.
2124	PARAF CHIP CHATA 5,0X70 BELENUS C/200	CX-2-CT
22498	PARAF CHIP CHATA 5,0X70 CISOER C/100	CX-1-CT
2106	PARAF CHIP CHATA 5,0X80 BELENUS C/200	CX-2-CT
29026	PARAF CHIP CHATA 5,0X80 CISOER C/100	CX-1-CT
22499	PARAF CHIP CHATA 5,0X80 CISOER C/100	CX-1-CT
2100	PARAF CHIP CHATA 5,0X80 BELENUS C/200	CX-2-CT
19782	PARAF CHIP CHATA 6,0X025 BELENUS C/200	CX-2-CT
29096	PARAF CHIP CHATA 6,0X025 CISOER C/300...	CX-3-CT
19775	PARAF CHIP CHATA 6,0X030 BELENUS C/200	CX-2-CT
20602	PARAF CHIP CHATA 6,0X030 CISOER C/300	CX-3-CT
20147	PARAF CHIP CHATA 6,0X035 BELENUS C/200	CX-2-CT
20069	PARAF CHIP CHATA 6,0X035 CISOER C/200	CX-2-CT
19784	PARAF CHIP CHATA 6,0X040 BELENUS C/200	CX-2-CT
20070	PARAF CHIP CHATA 6,0X040 CISOER C/200	CX-2-CT
19785	PARAF CHIP CHATA 6,0X045 BELENUS C/200	CX-2-CT
20071	PARAF CHIP CHATA 6,0X045 CISOER C/200	CX-2-CT
2096	PARAF CHIP CHATA 6,0X050 BELENUS C/200	CX-2-CT
7677	PARAF CHIP CHATA 6,0X050 CISOER C/200	CX-2-CT
19776	PARAF CHIP CHATA 6,0X060 BELENUS C/200	CX-2-CT
29099	PARAF CHIP CHATA 6,0X060 CISOER C/100	CX-1-CT
2290	PARAF CHIP CHATA 6,0X070 BELENUS C/200	CX-2-CT
29098	PARAF CHIP CHATA 6,0X070 CISOER C/100	CX-1-CT
29010	PARAF CHIP CHATA 6,0X080 CISOER C/100	CX-1-CT
28885	PARAF CHIP CHATA 6,0X090 CISOER	CT
3632	PARAF CHIP CHATA 6,0X100 BELENUS C/200	CX-2-CT
28943	PARAF CHIP CHATA 6,0X100 CISOER	CT
2125	PARAF CHIP CHATA 6,0X80 BELENUS C/200	CX-2-CT
10061	PARAF CHIP FLANGEADA 4,0X30	CX-5-CT
10063	PARAF CHIP FLANGEADA 4,0X40	CX-5-CT
10215	PARAF CHIP FLANGEADA 4,0X50	CX-7-CT
10068	PARAF CHIP FLANGEADA 4,5X25	CX-5-CT
10070	PARAF CHIP FLANGEADA 4,5X30	CX-5-CT
10072	PARAF CHIP FLANGEADA 4,5X40	CX-3-CT
10217	PARAF CHIP FLANGEADA 4,5X50	CX-3-CT
10074	PARAF CHIP FLANGEADA 4,5X30	CX-5-CT
7693	PARAF CHIP FLANGEADA 5,0X35 C/300	CX-3-CT
10076	PARAF CHIP FLANGEADA 5,0X40	CX-3-CT
7694	PARAF CHIP FLANGEADA 5,0X45 C/300	CX-3-CT
7695	PARAF CHIP FLANGEADA 5,0X50 C/300	CX-3-CT
26635	PARAF CHIP PANELA 4,0X14 CISOER C/1000	CX-10-CT
10005	PARAF CHIP PANELA 4,0X16 CISOER C/1000	CX-10-CT



FIXADORES

DICA DO REI PARAFUSO CHIP

São fixadores desenvolvidos exclusivamente para a indústria moveleira, utilizados na fabricação de móveis em madeiras leves (pinos e aglomerados) e MDF.

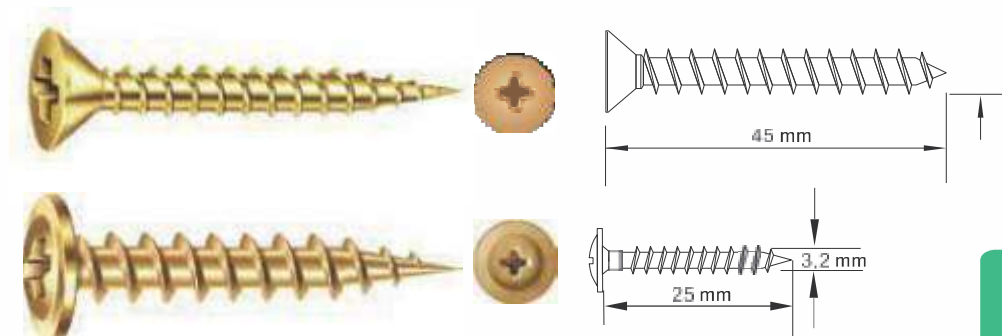

3,5 x 12



3,5 x 14



3,5 x 16

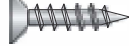

3,5 x 25

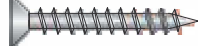

3,5 x 35

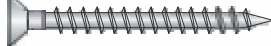

4,0 x 14

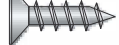

4,0 x 16



4,0 x 20



4,0 x 22



4,0 x 25



4,0 x 30



4,0 x 35



4,0 x 40



4,0 x 45



4,0 x 50



4,5 x 25



4,5 x 30



4,5 x 40



4,5 x 45



4,5 x 50



5,0 x 25

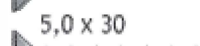

5,0 x 30

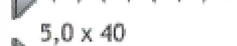

5,0 x 40



6,0 x 40



6,0 x 50



6,0 x 60



PARAFUSO FRANCÊS



Zincado



Polido

CÓD.	DESCRIÇÃO	EMB.
6169	PARAF FRANCES AA 3/16X3/4 CISERC/500	CX-5-CT
19774	PARAF FRANCES AB 3/16X1 BELENU C/500	CX-5-CT
12980	PARAF FRANCES AB 3/16X1 BELENU ZB C/500	CX-5-CT
3746	PARAF FRANCES AB 3/16X1 CISER C/500	CX-5-CT
7291	PARAF FRANCES AB 3/16X1 CISER ZB C/500	CX-5-CT
19937	PARAF FRANCES AB 3/16X1.1/4 BE C/500	CX-5-CT
16852	PARAF FRANCES AC 3/16X1.1/2 BEL ZB C/500	CX-5-CT
17376	PARAF FRANCES AC 3/16X1.1/2 BELC/500	CX-5-CT
3748	PARAF FRANCES AC 3/16X1.1/2 CISC/500	CX-5-CT
6306	PARAF FRANCES AC 3/16X1.1/2 CISER ZB C/500	CX-5-CT
16201	PARAF FRANCES AD 3/16X1.3/4 BELC/500	CX-5-CT
16491	PARAF FRANCES AE 3/16X2 BELENU C/500	CX-5-CT
16855	PARAF FRANCES AE 3/16X2 BELENU ZB C/500	CX-5-CT
3750	PARAF FRANCES AE 3/16X2 CISER C/500	CX-5-CT
6310	PARAF FRANCES AE 3/16X2 CISER ZB C/500	CX-5-CT
17087	PARAF FRANCES BB 1/4X1 BELENU C/500	CX-5-CT
3286	PARAF FRANCES BB 1/4X1 BELENU ZB C/500	CX-5-CT
3756	PARAF FRANCES BB 1/4X1 CISER C/500	CX-5-CT
6295	PARAF FRANCES BB 1/4X1 CISER ZB C/500	CX-5-CT
16554	PARAF FRANCES BC 1/4X1.1/4 BEL C/500	CX-5-CT
6366	PARAF FRANCES BC 1/4X1.1/4 BEL ZB C/500	CX-5-CT
3757	PARAF FRANCES BC 1/4X1.1/4 CISEC/500	CX-5-CT
12539	PARAF FRANCES BD 1/4X1.1/2 BEL C/200	CX-2-CT
3287	PARAF FRANCES BD 1/4X1.1/2 BEL ZB C/200	CX-2-CT
3758	PARAF FRANCES BD 1/4X1.1/2 CISC/200	CX-2-CT
6296	PARAF FRANCES BD 1/4X1.1/2 CISER ZB C/200	CX-2-CT
12540	PARAF FRANCES BE 1/4X1.3/4 BEL C/200	CX-2-CT
12541	PARAF FRANCES BF 1/4X2 BELENU C/200	CX-2-CT
3288	PARAF FRANCES BF 1/4X2 BELENU ZB C/200	CX-2-CT
3760	PARAF FRANCES BF 1/4X2 CISER C/200	CX-2-CT
6297	PARAF FRANCES BF 1/4X2 CISER ZB C/200	CX-2-CT
12542	PARAF FRANCES BG 1/4X2.1/4 BEL C/200	CX-2-CT
20653	PARAF FRANCES BG 1/4X2.1/4 BEL ZB C/200	CX-2-CT
3761	PARAF FRANCES BG 1/4X2.3/4 CISEC/200	CX-2-CT
16202	PARAF FRANCES BH 1/4X2.1/2 BEL C/200	CX-2-CT
3289	PARAF FRANCES BH 1/4X2.1/2 BEL ZB C/200	CX-2-CT
3762	PARAF FRANCES BH 1/4X2.1/2 CISEC/200	CX-2-CT
6014	PARAF FRANCES BH 1/4X2.1/2 ZINC CISEC/200	CX-2-CT
16204	PARAF FRANCES BI 1/4X2.3/4 BEL C/200	CX-2-CT
3763	PARAF FRANCES BI 1/4X2.3/4 CISEC/200	CX-2-CT
16493	PARAF FRANCES BJ 1/4X3 BELENU C/200	CX-2-CT
3290	PARAF FRANCES BJ 1/4X3 BELENU ZB C/200	CX-2-CT
3764	PARAF FRANCES BJ 1/4X3 CISER C/200	CX-2-CT
6298	PARAF FRANCES BJ 1/4X3 CISER ZB C/200	CX-2-CT
16205	PARAF FRANCES BL 1/4X3.1/2 BEL C/200	CX-2-CT
6367	PARAF FRANCES BL 1/4X3.1/2 BEL ZB C/200	CX-2-CT
3766	PARAF FRANCES BL 1/4X3.1/2 CISEC/200	CX-2-CT
6299	PARAF FRANCES BL 1/4X3.1/2 CISER ZB C/200	CX-2-CT
16494	PARAF FRANCES BM 1/4X4 BELENU C/200	CX-2-CT
6368	PARAF FRANCES BM 1/4X4 BELENU ZB C/200	CX-2-CT
3767	PARAF FRANCES BM 1/4X4 CISER C/200	CX-2-CT
6300	PARAF FRANCES BM 1/4X4 CISER ZB C/200	CX-2-CT
16964	PARAF FRANCES BN 1/4X4.1/2 BEL C/200	CX-2-CT
3768	PARAF FRANCES BN 1/4X4.1/2 CISEC/200	CX-2-CT
6301	PARAF FRANCES BN 1/4X4.1/2 CISER ZB C/200	CX-2-CT
16206	PARAF FRANCES BO 1/4X5 BELENU C/100	CX-1-CT
6369	PARAF FRANCES BO 1/4X5 BELENU ZB C/100	CX-1-CT
3769	PARAF FRANCES BO 1/4X5 CISER C/100	CX-1-CT
6302	PARAF FRANCES BO 1/4X5 CISER ZB C/100	CX-1-CT
27394	PARAF FRANCES CA 5/16X3/4 CISER C/200	CX-2-CT
16207	PARAF FRANCES CB 5/16X1 BELENU C/200	CX-2-CT
6374	PARAF FRANCES CB 5/16X1 BELENU ZB C/200	CX-2-CT
3771	PARAF FRANCES CB 5/16X1 CISER C/200	CX-2-CT
6322	PARAF FRANCES CB 5/16X1 CISER ZB C/200	CX-2-CT
3772	PARAF FRANCES CC 5/16X1.1/4 CISC/200	CX-2-CT
3291	PARAF FRANCES CD 5/16X1.1/2 BEL ZB C/200	CX-2-CT
16496	PARAF FRANCES CD 5/16X1.1/2 BELC/200	CX-2-CT
3773	PARAF FRANCES CD 5/16X1.1/2 CISC/200	CX-2-CT
6323	PARAF FRANCES CD 5/16X1.1/2 CISER ZB C/200	CX-2-CT
16497	PARAF FRANCES CE 5/16X1.3/4 BELC/200	CX-2-CT
3774	PARAF FRANCES CE 5/16X1.3/4 CISC/200	CX-2-CT
16208	PARAF FRANCES CF 5/16X2 BELENU C/200	CX-2-CT
3292	PARAF FRANCES CF 5/16X2 BELENU ZB C/200	CX-2-CT
3775	PARAF FRANCES CF 5/16X2 CISER C/200	CX-2-CT
7364	PARAF FRANCES CF 5/16X2 CISER ZB C/200	CX-2-CT
6376	PARAF FRANCES CG 5/16X2.1/4 BEL ZB C/200	CX-2-CT
16209	PARAF FRANCES CG 5/16X2.1/4 BELC/200	CX-2-CT

CÓD.	DESCRIÇÃO	EMB.
3776	PARAF FRANCES CG 5/16X2.1/4 CISC/200	CX-2-CT
3293	PARAF FRANCES CH 5/16X2.1/2 BEL ZB C/200	CX-2-CT
16210	PARAF FRANCES CH 5/16X2.1/2 BELC/200	CX-2-CT
3777	PARAF FRANCES CH 5/16X2.1/2 CISC/200	CX-2-CT
6324	PARAF FRANCES CH 5/16X2.1/2 CISER ZB C/200	CX-2-CT
16498	PARAF FRANCES CI 5/16X2.3/4 BELC/200	CX-2-CT
3778	PARAF FRANCES CI 5/16X2.3/4 CISC/200	CX-2-CT
12530	PARAF FRANCES CJ 5/16X3 BELENU C/100	CX-1-CT
3294	PARAF FRANCES CJ 5/16X3 BELENU ZB C/100	CX-1-CT
3779	PARAF FRANCES CJ 5/16X3 CISER C/100	CX-1-CT
6325	PARAF FRANCES CJ 5/16X3 CISER ZB C/100	CX-1-CT
15959	PARAF FRANCES CL 5/16X3.1/4 BELC/100	CX-1-CT
17703	PARAF FRANCES CL 5/16X3.1/4 CISC/100	CX-1-CT
3295	PARAF FRANCES CL 5/16X3.1/2 BEL ZB C/100	CX-1-CT
12531	PARAF FRANCES CL 5/16X3.1/2 BELC/100	CX-1-CT
3781	PARAF FRANCES CL 5/16X3.1/2 CISC/100	CX-1-CT
6326	PARAF FRANCES CL 5/16X3.1/2 CISER ZB C/100	CX-1-CT
12532	PARAF FRANCES CM 5/16X4 BELENU C/100	CX-1-CT
3314	PARAF FRANCES CM 5/16X4 BELENU ZB C/100	CX-1-CT
3782	PARAF FRANCES CM 5/16X4 CISER C/100	CX-1-CT
6327	PARAF FRANCES CM 5/16X4 CISER ZB C/100	CX-1-CT
6803	PARAF FRANCES CN 5/16X4.1/2 BEL ZB C/100	CX-1-CT
12533	PARAF FRANCES CN 5/16X4.1/2 BELC/100	CX-1-CT
3783	PARAF FRANCES CN 5/16X4.1/2 CISC/100	CX-1-CT
6328	PARAF FRANCES CN 5/16X4.1/2 CISER ZB C/100	CX-1-CT
12534	PARAF FRANCES CO 5/16X5 BELENU C/100	CX-1-CT
3310	PARAF FRANCES CO 5/16X5 BELENU ZB C/100	CX-1-CT
3784	PARAF FRANCES CO 5/16X5 CISER C/100	CX-1-CT
6329	PARAF FRANCES CO 5/16X5 CISER ZB C/100	CX-1-CT
12535	PARAF FRANCES CP 5/16X5.1/2 BE C/100	CX-1-CT
6330	PARAF FRANCES CP 5/16X5.1/2 CISER ZB C/100	CX-1-CT
12536	PARAF FRANCES CQ 5/16X6 BELENU C/100	CX-1-CT
3296	PARAF FRANCES CQ 5/16X6 BELENU ZB C/100	CX-1-CT
3786	PARAF FRANCES CQ 5/16X6 CISER C/100	CX-1-CT
7371	PARAF FRANCES CQ 5/16X6 CISER ZB C/100	CX-1-CT
3787	PARAF FRANCES CR 5/16X6.1/2 CISC/100	CX-1-CT
13120	PARAF FRANCES CR 5/16X6.1/2 ZB CISER C/100	CX-1-CT
16212	PARAF FRANCES CR 5/16X7 BELENU C/100	CX-1-CT
3311	PARAF FRANCES CS 5/16X7 BELENU ZB C/100	CX-1-CT
3788	PARAF FRANCES CS 5/16X7 CISER C/100	CX-1-CT
6332	PARAF FRANCES CS 5/16X7 CISER ZB C/100	CX-1-CT
3789	PARAF FRANCES CT 5/16X7.1/2 CISC/100	CX-1-CT
6333	PARAF FRANCES CT 5/16X7.1/2 CISER ZB C/100	CX-1-CT
16214	PARAF FRANCES CU 5/16X8 BELENU C/100	CX-1-CT
3790	PARAF FRANCES CU 5/16X8 CISER C/100	CX-1-CT
3350	PARAF FRANCES CU 5/16X8 ZB BELENU C/100	CX-1-CT
16215	PARAF FRANCES DA 3/8X1 BELENU C/200	CX-2-CT
3797	PARAF FRANCES DA 3/8X1 CISER C/200	CX-2-CT
6313	PARAF FRANCES DA 3/8X1 CISER ZB C/200	CX-2-CT
3298	PARAF FRANCES DC 3/8X1.1/2 BEL ZB C/100	CX-2-CT
3798	PARAF FRANCES DC 3/8X1.1/2 CISEC/100	CX-1-CT
12518	PARAF FRANCES DC 3/8X2 BELENU C/100	CX-1-CT
3300	PARAF FRANCES DE 3/8X2 BELENU ZB C/100	CX-1-CT
3801	PARAF FRANCES DE 3/8X2 CISER C/100	CX-1-CT
6315	PARAF FRANCES DE 3/8X2 CISER ZB C/100	CX-1-CT
12519	PARAF FRANCES DG 3/8X2.1/2 BEL C/100	CX-1-CT
3302	PARAF FRANCES DG 3/8X2.1/2 BEL ZB C/100	CX-1-CT
3803	PARAF FRANCES DG 3/8X2.1/2 CISEC/100	CX-1-CT
6316	PARAF FRANCES DG 3/8X2.1/2 CISER ZB C/100	CX-1-CT
12520	PARAF FRANCES DI 3/8X3 BELENU C/100	CX-1-CT
3303	PARAF FRANCES DI 3/8X3 BELENU ZB C/100	CX-1-CT
3805	PARAF FRANCES DI 3/8X3 CISER C/100	CX-1-CT
2580	PARAF FRANCES DI 3/8X3 ZB CISER C/100...	CX-1-CT
12555	PARAF FRANCES DK 3/8X3.1/2 BELENU C/100	CX-1-CT
3304	PARAF FRANCES DK 3/8X3.1/2 BELENU ZB C/100	CX-1-CT
3807	PARAF FRANCES DK 3/8X3.1/2 CISEC/100	CX-1-CT
6317	PARAF FRANCES DK 3/8X3.1/2 CISER ZB C/100	CX-1-CT
16216	PARAF FRANCES DL 3/8X4 BELENU C/50	CX
3315	PARAF FRANCES DL 3/8X4 BELENU ZB C/50	CX
3808	PARAF FRANCES DL 3/8X4 CISER C/50	CX
6318	PARAF FRANCES DL 3/8X4 CISER ZB C/50	CX
12522	PARAF FRANCES DM 3/8X4.1/2 BELE C/50	CX
3305	PARAF FRANCES DM 3/8X4.1/2 BELE ZB C/50	CX
6319	PARAF FRANCES DM 3/8X4.1/2 CISER ZB C/50	CX
3809	PARAF FRANCES DM 3/8X4.1/2 CISC/50	CX
12556	PARAF FRANCES DN 3/8X5 BELENU C/50	CX
3306	PARAF FRANCES DN 3/8X5 BELENU ZB C/50	CX

CÓD.	DESCRIÇÃO	EMB.
3810	PARAF FRANCES DN 3/8X5 CISER C/50	CX
6320	PARAF FRANCES DN 3/8X5 CISER ZB C/50	CX
12523	PARAF FRANCES DO 3/8X5.1/2 BELE C/50	CX
6370	PARAF FRANCES DO 3/8X5.1/2 BELE ZB C/50	CX
6321	PARAF FRANCES DO 3/8X5.1/2 CISER ZB C/50	CX
3811	PARAF FRANCES DO 3/8X5.1/2 CISC/50	CX
12524	PARAF FRANCES DP 3/8X6 BELENU C/50	CX
3313	PARAF FRANCES DP 3/8X6 BELENU ZB C/50	CX
29180	PARAF FRANCES DP 3/8X6 CISER C/50	CX
6275	PARAF FRANCES DP 3/8X6 CISER ZB C/50	CX
16217	PARAF FRANCES DQ 3/8X6.1/2 BEL C/50	CX
6276	PARAF FRANCES DQ 3/8X6.1/2 BEL ZB C/50	CX
3813	PARAF FRANCES DQ 3/8X6.1/2 CISC/50	CX
16218	PARAF FRANCES DQ 3/8X6.1/2 CISER C/50	CX
3307	PARAF FRANCES DR 3/8X7 BELENU ZB C/50	CX
3814	PARAF FRANCES DR 3/8X7 CISER C/50	CX
6278	PARAF FRANCES DR 3/8X7 CISER ZB C/50	CX
16499	PARAF FRANCES DS 3/8X7.1/2 BELENU C/50	CX
6373	PARAF FRANCES DS 3/8X7.1/2 BELENU ZB C/50	CX
6279	PARAF FRANCES DS 3/8X7.1/2 CISER ZB C/50	CX
3815	PARAF FRANCES DS 3/8X7.1/2 CISC/50	CX
16219	PARAF FRANCES DT 3/8X8 BELENU C/50	CX
3308	PARAF FRANCES DT 3/8X8 BELENU ZB C/50	CX
3816	PARAF FRANCES DT 3/8X8 CISER C/50	CX
17070	PARAF FRANCES DT 3/8X8 CISER ZB C/50	CX
16814	PARAF FRANCES DT 3/8X8.1/2 BEL C/50	CX
3817	PARAF FRANCES DT 3/8X8.1/2 CISC/50	CX
13497	PARAF FRANCES DV 3/8X9 BELENU C/50	CX
3309	PARAF FRANCES DV 3/8X9 BELENU ZB C/50	CX
3818	PARAF FRANCES DV 3/8X9 CISER C/50	CX
6280	PARAF FRANCES DV 3/8X9 CISER ZB C/50	CX
16746	PARAF FRANCES DW 3/8X9.1/2 BELE C/50	CX
6281	PARAF FRANCES DW 3/8X9.1/2 CISER ZB C/50	CX
3819	PARAF FRANCES DW 3/8X9.1/2 CISC/50	CX
13498	PARAF FRANCES DX 3/8X10 BELENU C/50	CX
3820	PARAF FRANCES DX 3/8X10 CISER C/50	CX
7363	PARAF FRANCES DX 3/8X10 CISER ZB C/50	CX
3351	PARAF FRANCES DX 3/8X10 ZB BELENU C/50	CX
16220	PARAF FRANCES DY 3/8X11 BELENU C/50	CX
3821	PARAF FRANCES DY 3/8X11 CISER C/50	CX
16745	PARAF FRANCES DZ 3/8X12 BELENU C/50	CX
12848	PARAF FRANCES FB 1/2X2 BELENU C/50	CX
6363	PARAF FRANCES FB 1/2X2 BELENU ZB C/50	CX
3856	PARAF FRANCES FB 1/2X2 CISER C/50	CX
19156	PARAF FRANCES FD 1/2X2.1/2 BELE C/50	CX
3858	PARAF FRANCES FD 1/2X2.1/2 CISC/50	CX
19790	PARAF FRANCES FF 1/2X3 BELENU C/50	CX
3860	PARAF FRANCES FF 1/2X3 CISER C/50	CX
19791	PARAF FRANCES FH 1/2X3.1/2 BELE C/50	CX
3862	PARAF FRANCES FH 1/2X3.1/2 CISC/50	CX
12525	PARAF FRANCES FI 1/2X4 BELENU C/50	CX
3863	PARAF FRANCES FI 1/2X4 CISER C/50	CX
12849	PARAF FRANCES FJ 1/2X4.1/2 BELE C/50	CX
3864	PARAF FRANCES FJ 1/2X4.1/2 CISC/50	CX
16500	PARAF FRANCES FK 1/2X5 BELENU C/50	CX
3865	PARAF FRANCES FK 1/2X5 CISER C/50	CX
16221	PARAF FRANCES FL 1/2X5.1/2 BELE C/50	CX
3866	PARAF FRANCES FL 1/2X5.1/2 CISC/50	CX
16470	PARAF FRANCES FM 1/2X6 BELENU C/50	CX
3867	PARAF FRANCES FM 1/2X6 CISER C/50	CX
3868	PARAF FRANCES FN 1/2X6.1/2 CISC/50	CX
16223	PARAF FRANCES FO 1/2X7 BELENU C/50	CX
3869	PARAF FRANCES FO 1/2X7 CISER C/50	CX
16224	PARAF FRANCES FP 1/2X8.1/2 BELENU C/20	CX
3870	PARAF FRANCES FP 1/2X7.1/2 CISC/50	CX
16501	PARAF FRANCES FQ 1/2X8 BELENU C/50	CX
3871	PARAF FRANCES FQ 1/2X8 CISER C/50	CX
3872	PARAF FRANCES FR 1/2X8.1/2 CISER C/100	CX
16225	PARAF FRANCES FS 1/2X9 BELENU C/20	CX
3873	PARAF FRANCES FS 1/2X9 CISER C/50	CX
16503	PARAF FRANCES FU 1/2X10 BELENU C/20	CX
14590	PARAF FRANCES FU 1/2X10 CISER C/50	CX
14443	PARAF FRANCES FU 1/2X11 CISER C/50	CX
3634	PARAF FRANCES GP 5/8X10 CISER C/20	CX
3635	PARAF FRANCES GQ 5/8X11 CISER C/20	CX



DICA DO REI

PARAFUSO FRANCÊS

É utilizado em carrocerias, cercas, bancos, móveis, máquinas e equipamentos agrícolas. Inclui-se no comprimento do parafuso o quadrado logo abaixo da cabeça, que fica embutido na montagem. É fornecido sem acabamento superficial.

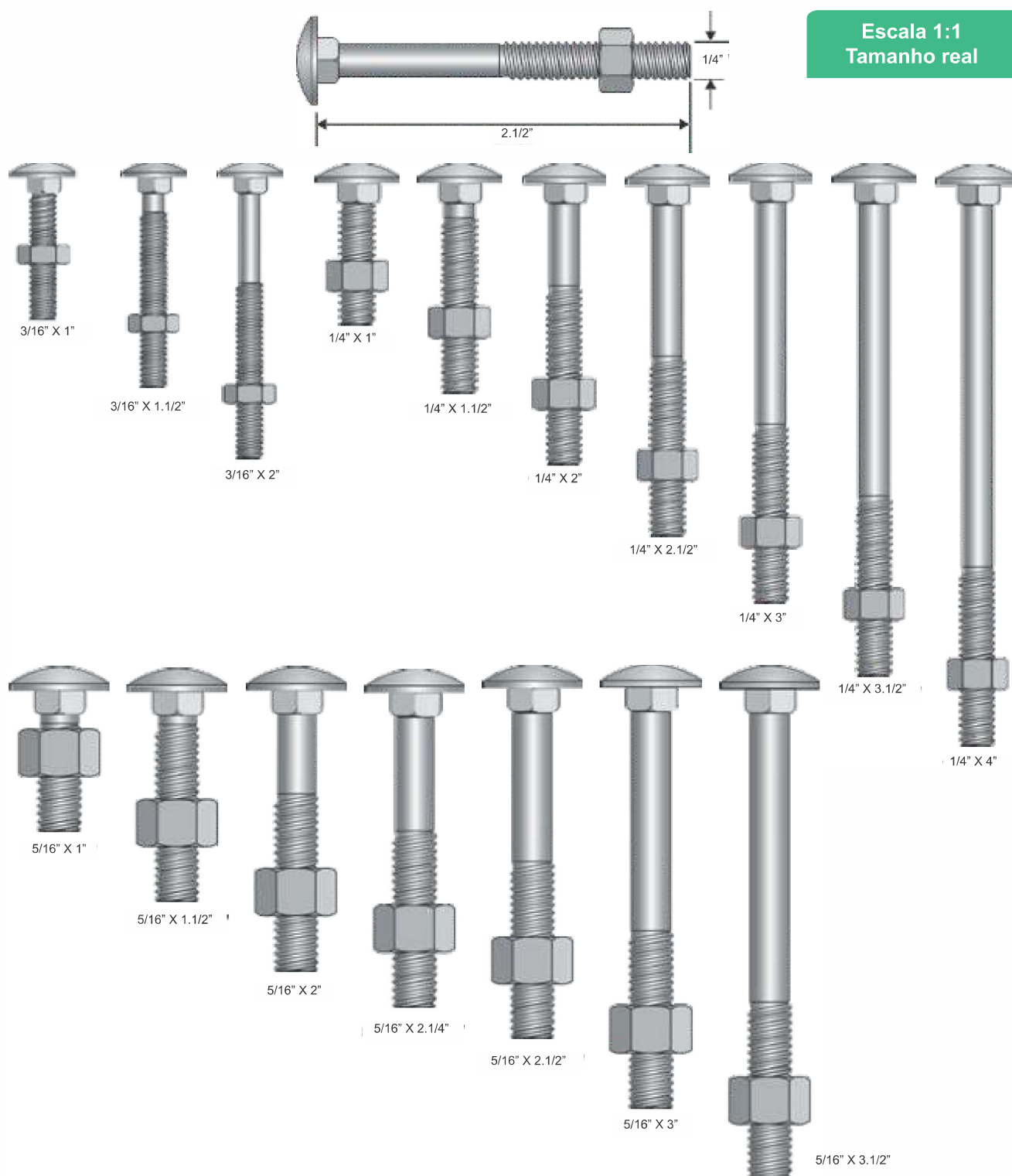

PARAFUSO FRANCÊS SEXTAVADO

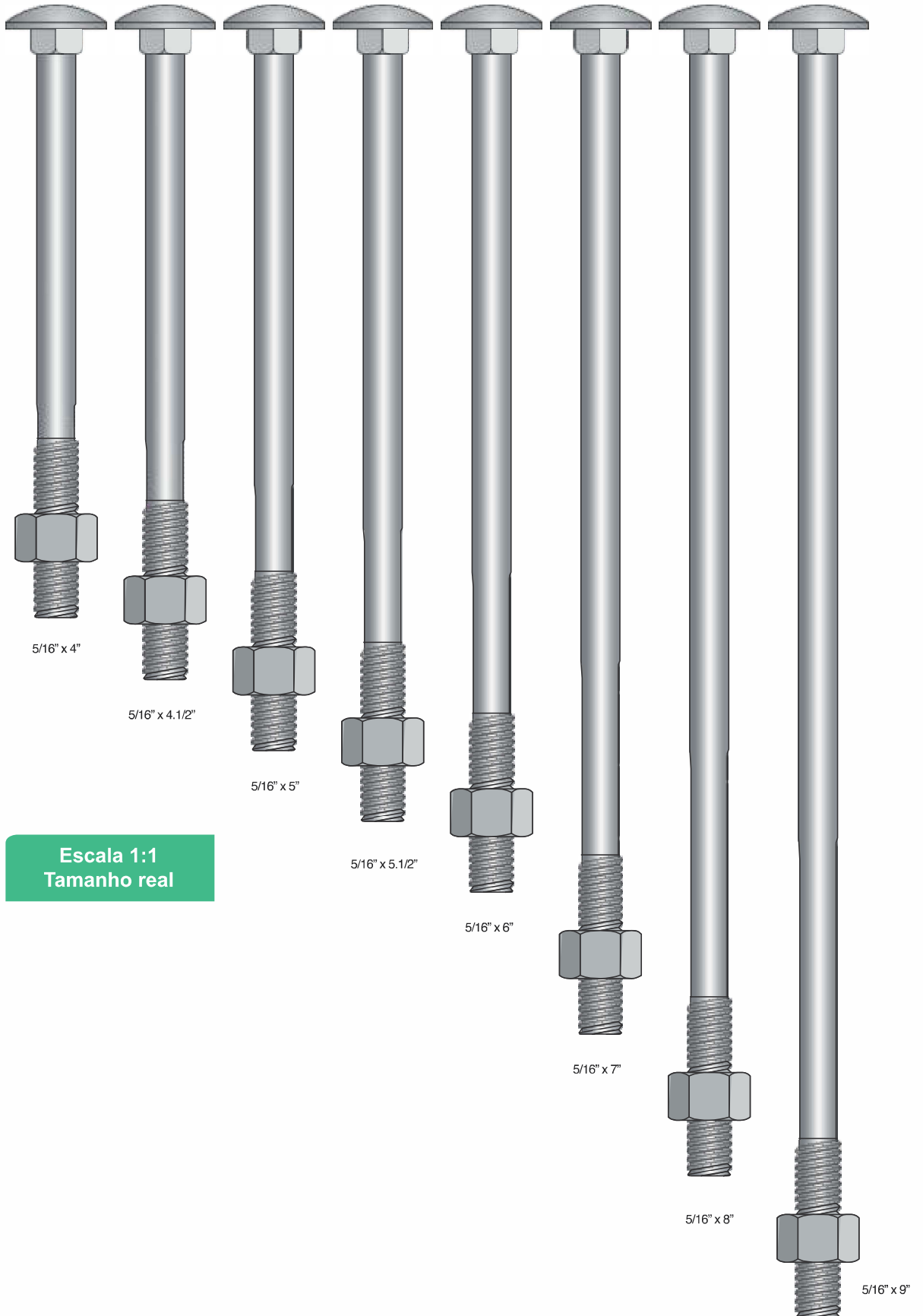

Escala 1:1
Tamanho real



FIXADORES

PARAFUSO FRANCÊS PORCA SEXTAVADA

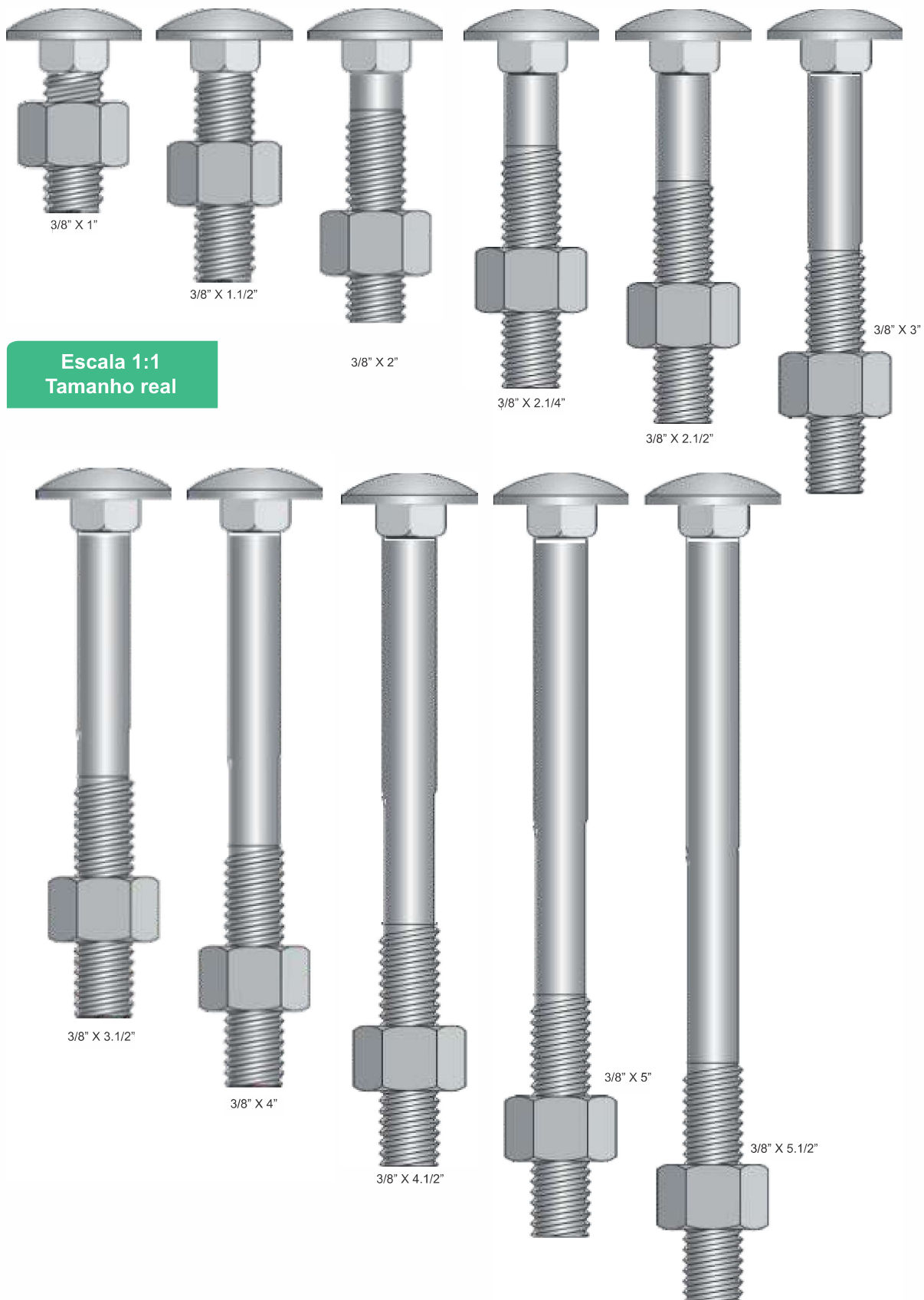

PARAFUSO FRANCÊS PORCA SEXTAVADA





FIXADORES

PARAFUSO FRANCÊS PORCA SEXTAVADA

Escala 1:1
Tamanho real



3/8" x 10"

PARAFUSO FRANCÊS PORCA SEXTAVADA

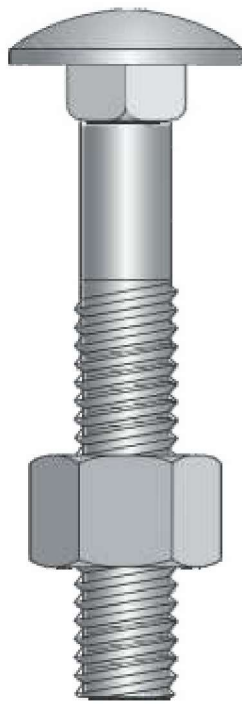

1/2" x 3"



1/2" x 4"



1/2" x 6"



1/2" x 6"



1/2" x 7"

Escala 1:1
Tamanho real



FIXADORES

PARAFUSO FRANCÊS PORCA SEXTAVADA

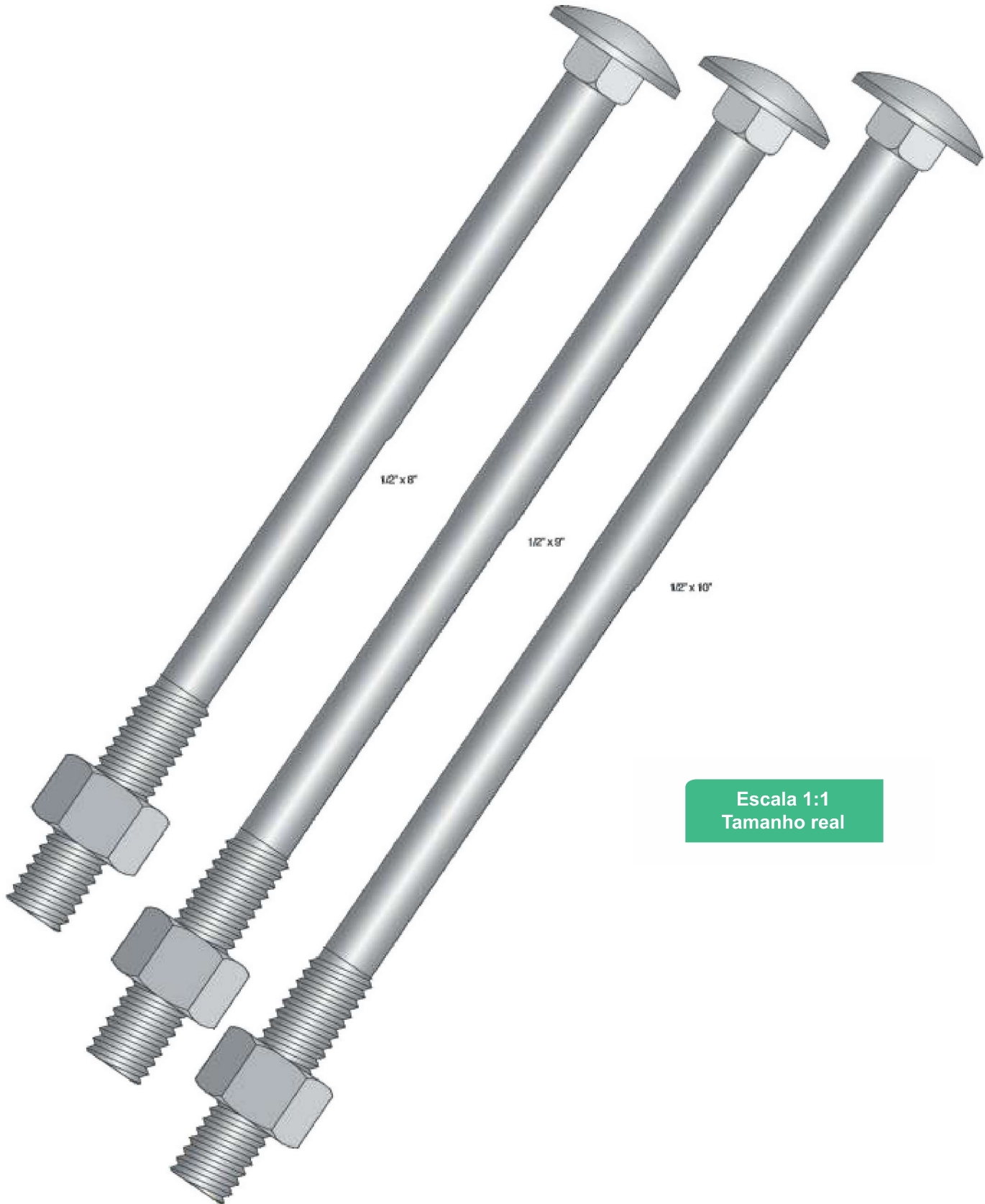

Escala 1:1
Tamanho real

PARAFUSO SEXTAVADO - AÇO (POL/MM)



RI - Rosca Inteira



RP - Rosca Parcial

CÓD.	DESCRIÇÃO	EMB.
13121	PARAF SEX ACO A 1/4X1 G5 UNC BEL C/250	CX-2.5-CT
10304	PARAF SEX ACO A 1/4X1 RI G5 C/200	CX-2-CT
25705	PARAF SEX ACO A 1/4X1/2 RI G5 C/200	CX-2-CT
27158	PARAF SEX ACO A 1/4X1/2RI G5 BEC/500	CX-5-CT
27265	PARAF SEX ACO A 1/4X3/4 RI G5 BEC/500	CX-5-CT
25706	PARAF SEX ACO A 1/4X3/4 RI G5 C/200	CX-2-CT
27159	PARAF SEX ACO A 1/4X5/8 RI G5 BEC/500	CX-5-CT
25707	PARAF SEX ACO A 1/4X5/8 RI G5 C/200	CX-2-CT
25708	PARAF SEX ACO A 1/4X7/8 RI G5 C/200	CX-2-CT
16228	PARAF SEX ACO B 1/4X1.1/4 G5 BEC/200	CX-2-CT
10306	PARAF SEX ACO B 1/4X1.1/4 RI G5 C/200	CX-2-CT
16229	PARAF SEX ACO C 1/4X1.1/2 G5 BEC/200	CX-2-CT
10307	PARAF SEX ACO C 1/4X1.1/2 RI G5 C/200	CX-2-CT
13290	PARAF SEX ACO C 1/4X1.3/4 G5 UNC BEL C/200	CX-2-CT
862	PARAF SEX ACO C 1/4X2 G5UNC RI BELC/150	CX-1.5-CT
15437	PARAF SEX ACO C 1/4X2 RI G5 C/200	CX-2-CT
25719	PARAF SEX ACO C 1/4X2.1/2 RP G5 C/200	CX-2-CT
27173	PARAF SEX ACO C 1/4X3 G5UNC BELC/100	CT
25720	PARAF SEX ACO C 1/4X3 RP G5 C/200	CX-2-CT
25721	PARAF SEX ACO C 1/4X3.1/2 RP G5 C/100	CT
27174	PARAF SEX ACO C 1/4X3.1/2G5UNC BC100	CT
25722	PARAF SEX ACO C 1/4X4 RP G5 C/100	CT
20601	PARAF SEX ACO D 5/16X1/2 RI G5 C/200	CX-2-CT
27266	PARAF SEX ACO D 5/16X3/4 G5 BELC/200	CX-2-CT
25714	PARAF SEX ACO D 5/16X3/4 RI G5 C/200	CX-2-CT
25715	PARAF SEX ACO D 5/16X3/8 RI G5 C/200	CX-2-CT
15798	PARAF SEX ACO E 5/16X1.1/2 G5UNC BEC/200	CX-2-CT
10308	PARAF SEX ACO E 5/16X1 RI G5 C/200	CX-2-CT
15799	PARAF SEX ACO E 5/16X1.1/2 G5 BC/200	CX-2-CT
842	PARAF SEX ACO E 5/16X1.1/2 RI G5 BELENU C/150CX-1.5-CT	CX-1.5-CT
10309	PARAF SEX ACO E 5/16X2.1/2 RI G5 BEC/200	CX-2-CT
3751	PARAF SEX ACO F 5/16X2 G5 BELE C/100	CX-1-CT
10310	PARAF SEX ACO F 5/16X2 RI G5 C/200	CX-2-CT
13044	PARAF SEX ACO F 5/16X2.1/2 RP G5 C/100	CX-1-CT
16700	PARAF SEX ACO F 5/16X2.1/2RI G5UNC B	CX-1-CT
16230	PARAF SEX ACO F 5/16X2.1/2RP G5UNC B	CX-1-CT
16232	PARAF SEX ACO F 5/16X3 RI G5UNC C/100	CX-1-CT
27177	PARAF SEX ACO F 5/16X3 RP G5 BEC/100	CT
13045	PARAF SEX ACO F 5/16X3 RP G5UNC C/100	CX-1-CT
13297	PARAF SEX ACO F 5/16X3.1/2 G5 UNC BELC/100	CT
25730	PARAF SEX ACO F 5/16X3.1/2 RP G5 C/100	CT
27572	PARAF SEX ACO F 5/16X4 RP G5 BEC/100	CX-1-CT
25811	PARAF SEX ACO F 5/16X4 RP G5 C/100	CT
3643	PARAF SEX ACO F 5/16X4.1/2 RP G5 C/100	CX-1-CT
13298	PARAF SEX ACO F 5/16X5 RP G5 UNC BELC/100	CX-1-CT
3644	PARAF SEX ACO F 5/16X5 RP G5 C/100	CT
3695	PARAF SEX ACO G 3/8X1 G5UNC BELC/100	CX-1-CT
10311	PARAF SEX ACO G 3/8X1 RI G5 UNC C/200	CX-2-CT
3712	PARAF SEX ACO G 3/8X1.1/2 G5 BEC/100	CX-1-CT
10312	PARAF SEX ACO G 3/8X1.1/2 RI G5 C/100	CX-1-CT
13046	PARAF SEX ACO G 3/8X1.1/4 RI G5 C/100	CX-1-CT
25709	PARAF SEX ACO G 3/8X1.3/4 RI G5 C/100	CT
855	PARAF SEX ACO G 3/8X2 G5 UNC RI BEC/100	CX-1-CT
10313	PARAF SEX ACO G 3/8X2 RI G5UNC C/100	CX-1-CT
25612	PARAF SEX ACO G 3/8X2.1/2 G5RI BC100	CX-1-CT
16505	PARAF SEX ACO G 3/8X2.1/2 G5RP BC100	CX-1-CT
10314	PARAF SEX ACO G 3/8X2.1/2 RP G5 C/100	CX-1-CT
773	PARAF SEX ACO G 3/8X2.1/2 RP G5 C/100...	CX-1-CT
25724	PARAF SEX ACO G 3/8X2.3/4 RP G5 C/100	CT
16233	PARAF SEX ACO G 3/8X3 G5 BELENU C/100	CX-1-CT
13047	PARAF SEX ACO G 3/8X3 RP G5UNC C/100	CX-1-CT
16234	PARAF SEX ACO G 3/8X3.1/2 G5 BEC/100	CX-1-CT
13048	PARAF SEX ACO G 3/8X3.1/2 RP G5 C/100	CX-1-CT
27245	PARAF SEX ACO G 3/8X4 G5UNC BELC/100	CX-1-CT
25725	PARAF SEX ACO G 3/8X4 RP G5 C/100	CT
27179	PARAF SEX ACO G 3/8X4.1/2 G5 BEC/50	CX
25702	PARAF SEX ACO G 3/8X4.1/2 RP G5 C/050	CX
27180	PARAF SEX ACO G 3/8X5 RP G5 BEC/50	CX
25726	PARAF SEX ACO G 3/8X5 RP G5 C/050	CX
25727	PARAF SEX ACO G 3/8X5.1/2 RP G5 C/050	CX
16506	PARAF SEX ACO H 7/16X1 G5 BELE C/200	CX-2-CT
13049	PARAF SEX ACO H 7/16X1 RI G5UNC C/200	CX-2-CT
16235	PARAF SEX ACO H 7/16X1.1/2 G5 BC/100	CX-1-CT
13050	PARAF SEX ACO H 7/16X1.1/2 RI G5 C/100	CX-1-CT
16236	PARAF SEX ACO H 7/16X1.1/4 G5 BC/200	CX-2-CT
15310	PARAF SEX ACO H 7/16X1.1/4 RI G5 C/200	CX-2-CT
23316	PARAF SEX ACO H 7/16X2 G5 BELE C/100	CT
13051	PARAF SEX ACO H 7/16X2 RI G5 C/100	CX-1-CT
16237	PARAF SEX ACO H 7/16X2.1/2 G5 BC/100	CX-1-CT
13052	PARAF SEX ACO H 7/16X2.1/2 RP G5 C/100	CX-1-CT
16238	PARAF SEX ACO H 7/16X3 G5UNC BEC/100	CX-1-CT
13053	PARAF SEX ACO H 7/16X3 RP G5UNC C/100	CX-1-CT
16239	PARAF SEX ACO H 7/16X3.1/2 G5 BEC/50	CX
13914	PARAF SEX ACO H 7/16X3.1/2 RP G5 C/50	CX
23324	PARAF SEX ACO H 7/16X4 G5UNC BELC/50	CX
19206	PARAF SEX ACO H 7/16X4 RP G5UNC C/50	CX
3689	PARAF SEX ACO H 7/16X4.1/2 RP G5 C/50	CX
4016	PARAF SEX ACO H 7/16X5 CISER R P G5 C/50	CX
13818	PARAF SEX ACO H 7/16X5 G5 UNC BEL C/50	CX
3752	PARAF SEX ACO I 1/2X1 G5UNC BELENU C/50	CX
13054	PARAF SEX ACO I 1/2X1 RI G5UNC C/100	CX-1-CT
849	PARAF SEX ACO I 1/2X1.1/2 G5 RI BEC/50	CX-0.5-CT

CÓD.	DESCRIÇÃO	EMB.
13055	PARAF SEX ACO I 1/2X1.1/2 RI G5 C/100	CX-1-CT
13303	PARAF SEX ACO I 1/2X1.1/4 G5 RI BEL UNC C/50	CX
21750	PARAF SEX ACO I 1/2X1.1/4 RI G5 C/100	CX-2-CT
13306	PARAF SEX ACO I 1/2X1.3/4 G5 RI BEL UNC C/50	CX-5-CT
25703	PARAF SEX ACO I 1/2X1.3/4 RI G5 C/100	CT
853	PARAF SEX ACO I 1/2X2 G5 RI BELENU C/50	CX-0.5-CT
13056	PARAF SEX ACO I 1/2X2 RI G5 UNC C/100	CX-1-CT
772	PARAF SEX ACO I 1/2X2 RI G5 UNC C/100...	CX-1-CT
25913	PARAF SEX ACO I 1/2X4 G5 BELENU C/50	CX
25717	PARAF SEX ACO I 1/2X2.1/2 RP G5 C/050	CX
15962	PARAF SEX ACO I 1/2X3 RI G5 BEL C/50	CX
13057	PARAF SEX ACO I 1/2X3 RP G5 UNC C/50	CX
15963	PARAF SEX ACO I 1/2X3.1/2 G5 BELENU C/50	CX
13058	PARAF SEX ACO I 1/2X3.1/2 RP G5 C/50	CX
15964	PARAF SEX ACO I 1/2X4 G5 BELENU C/50	CX
13059	PARAF SEX ACO I 1/2X4 RP G5UNC C/50	CX
27814	PARAF SEX ACO I 1/2X6 G5 BELENU C/50	CX
25733	PARAF SEX ACO I 1/2X4.1/2 RP G5 C/050	CX
27815	PARAF SEX ACO I 1/2X5 G5 BELENU C/50	CX
25734	PARAF SEX ACO I 1/2X5 RP G5 C/050	CX
13307	PARAF SEX ACO I 1/2X5 G5 UNC BEL C/50	CX
25735	PARAF SEX ACO I 1/2X5.1/2 RP G5 C/050	CX
14485	PARAF SEX ACO I 1/2X6 G5 UNC BEL C/50	CX
3841	PARAF SEX ACO I 1/2X6 RP G5 C/020	CX
27164	PARAF SEX ACO I 9/16X1 RI G5 BE C100	CT
22998	PARAF SEX ACO I 9/16X1 RI G5UNC C/100	CX-1-CT
23317	PARAF SEX ACO I 9/16X2.1/2 G5 BC/100	CT
22999	PARAF SEX ACO I 9/16X2.1/2 RI G5 C/100	CT
24541	PARAF SEX ACO I 9/16X2 RI G5 BE C/50	CX
23000	PARAF SEX ACO I 9/16X2 RI G5 C/050	CX
23325	PARAF SEX ACO I 9/16X2.1/2 G5 BEC/50	CX
23001	PARAF SEX ACO I 9/16X2.1/2 RP G5 C/50	CX
24938	PARAF SEX ACO I 9/16X3 G5 BEL C/50	CX
23002	PARAF SEX ACO I 9/16X3 RP G5UNC C/50	CX
23003	PARAF SEX ACO I 9/16X3.1/2 RP G5 C/50	CX
23326	PARAF SEX ACO I 9/16X4 RP G5 BEC/50	CX
23004	PARAF SEX ACO I 9/16X4 RP G5UNC C/20	CX
27576	PARAF SEX ACO J 5/8X1 G5 BELC/100	CX-1-CT
25737	PARAF SEX ACO J 5/8X1 RI G5 C/100	CT
27248	PARAF SEX ACO J 5/8X1.1/2 G5 BEC/50	CX
25738	PARAF SEX ACO J 5/8X1.1/2 RI G5 C/050	CX
27832	PARAF SEX ACO J 5/8X2 G5 RI BELC/50	CX
27921	PARAF SEX ACO J 5/8X2 RI G5 C/50	CX
778	PARAF SEX ACO J 5/8X2 RI G5 C/50...	CX
16241	PARAF SEX ACO J 5/8X2.1/2 G5 BEC/50	CX
13060	PARAF SEX ACO J 5/8X2.1/2 RP G5 C/50	CX
16508	PARAF SEX ACO J 5/8X3 G5UNC BELC/20	CX
13061	PARAF SEX ACO J 5/8X3 RP G5UNC C/20	CX
16509	PARAF SEX ACO J 5/8X3.1/2 G5 BEC/20	CX
13062	PARAF SEX ACO J 5/8X3.1/2 RP G5 C/20	CX
16242	PARAF SEX ACO J 5/8X4 G5UNC BELENU C/20	CX
13063	PARAF SEX ACO J 5/8X4 RP G5UNC C/20	CX
27822	PARAF SEX ACO J 5/8X4.1/2 RP G5 BEC/20	CX
25739	PARAF SEX ACO J 5/8X4.1/2 RP G5 C/20	CX
16243	PARAF SEX ACO J 5/8X5 G5 BELENU C/20	CX
13043	PARAF SEX ACO J 5/8X5 RP G5UNC C/20	CX
16869	PARAF SEX ACO J 5/8X5.1/2 G5 BELENU C/20	CX
16244	PARAF SEX ACO J 5/8X6 G5 BELENU C/20	CX
14697	PARAF SEX ACO J 5/8X6 RP G5UNC C/20	CT
27268	PARAF SEX ACO J 5/8X7 G5 BELENU C/20	CX
25740	PARAF SEX ACO J 5/8X7 RP G5 C/020	CX
27269	PARAF SEX ACO J 5/8X8 G5 BELENU C/20	CX
25741	PARAF SEX ACO J 5/8X8 RP G5 C/020	CX
23083	PARAF SEX ACO JK 5/8X10 RP G5 C/020	CX
13308	PARAF SEX ACO K 3/4X1 UNC G5 BEL C/50	CX
27165	PARAF SEX ACO K 3/4X1.1/2 RI G5 BC/50	CX
25736	PARAF SEX ACO K 3/4X1.1/2 RI G5 C/050	CX
16252	PARAF SEX ACO K 3/4X2 G5 BELENU C/50	CX
14725	PARAF SEX ACO K 3/4X2 RI G5UNC C/20	CX
23351	PARAF SEX ACO K 3/4X2.1/2 G5 BE C/50	CX
14726	PARAF SEX ACO K 3/4X2.1/2 RP G5 C/50	CX-2-CT
16245	PARAF SEX ACO K 3/4X3 G5UNC BEL C/20	CX
12348	PARAF SEX ACO K 3/4X3 RP G5UNC C/20	CX-1-CT
16246	PARAF SEX ACO K 3/4X3.1/2 G5 BEC/20	CX
13005	PARAF SEX ACO K 3/4X3.1/2 RP G5 C/20...	CX
20144	PARAF SEX ACO K 3/4X4 G5 BELENU C/20	CX
13006	PARAF SEX ACO K 3/4X4 RP G5UNC C/20	CT
774	PARAF SEX ACO K 3/4X4 RP G5UNC C/20...	CX-1-CT
27183	PARAF SEX ACO K 3/4X4.1/2 G5 BE C/20	CX
25321	PARAF SEX ACO K 3/4X4.1/2 RP G5 C/20	CX
16247	PARAF SEX ACO K 3/4X5 G5UNC BELENU C/20	CX
13007	PARAF SEX ACO K 3/4X5 RP G5UNC C/20	CX
27569	PARAF SEX ACO K 3/4X5.1/2 G5BEL C/20	CX
25747	PARAF SEX ACO K 3/4X5.1/2 RP G5 C/020	CX
20145	PARAF SEX ACO K 3/4X6 G5UNC BELENU C/20	CX
13008	PARAF SEX ACO K 3/4X6 RP G5UNC C/20	CX
25748	PARAF SEX ACO K 3/4X6.1/2 RP G5 C/020	CX
16510	PARAF SEX ACO K 3/4X7 G5UNC BELENU C/20	CX
16248	PARAF SEX ACO K 3/4X7.1/2 G5UNC BELE	CX
13510	PARAF SEX ACO K 3/4X7.1/2 RP G5 C/20	CX
25749	PARAF SEX ACO K 3/4X8 RP G5 C/020	CX
24028	PARAF SEX ACO K 3/4X9 G5UNC BELENU C/20	CX

CÓD.	DESCRIÇÃO	EMB.
28683	PARAF SEX ACO L 7/8X010 RP G5UNC C10	CX
25814	PARAF SEX ACO L 7/8X2.1/2 RP G5 C/20	CX
16249	PARAF SEX ACO L 7/8X3 G5UNC BEL C/20	CX
13009	PARAF SEX ACO L 7/8X3 RP G5UNC C/20	CX
20762	PARAF SEX ACO L 7/8X3.1/2 G5 BE C/20	CX
13010	PARAF SEX ACO L 7/8X3.1/2 RP G5 C/20	CX
16250	PARAF SEX ACO L 7/8X4 G5UNC BEL C/20	CX-1-CT
20763	PARAF SEX ACO L 7/8X4.1/2 G5 BE C/20	CX
13011	PARAF SEX ACO L 7/8X4.1/2 RP G5 C/10	CX
16251	PARAF SEX ACO L 7/8X5 G5UNC BELENU C/20	CX
13012	PARAF SEX ACO L 7/8X5 RP G5UNC C/10	CX
19814	PARAF SEX ACO L 7/8X5.1/2 RP G5 C/10	CX
20765	PARAF SEX ACO L 7/8X6 G5UNC BELENU C/20	CX
25750	PARAF SEX ACO L 7/8X6.1/2 RP G5 C/10	CX
20766	PARAF SEX ACO L 7/8X7 G5UNC BELENU C/20	CX
13014	PARAF SEX ACO L 7/8X7 RP G5UNC C/10	CX
20767	PARAF SEX ACO L 7/8X7.1/2 G5UNC BELENU C/20	CX
13015	PARAF SEX ACO L 7/8X8 RP G5UNC C/10	CX
25498	PARAF SEX ACO L 7/8X9 G5UNC BELENU C/20	CX
25742	PARAF SEX ACO M 1X10 RP G5 C/010	CX
16253	PARAF SEX ACO M 1X3 G5UNC BELENU C/10	CX
13016	PARAF SEX ACO M 1X3 RP G5UNC C/10	CX
25743	PARAF SEX ACO M 1X3.1/2 RP G5 C/010	CX
20745	PARAF SEX ACO M 1X4 G5UNC BELENU C/10	CX
13017	PARAF SEX ACO M 1X4 RP G5UNC C/10	CX
776	PARAF SEX ACO M 1X4 RP G5UNC C/10...	CX
27188	PARAF SEX ACO M 1X4.1/2 G5UNC BEC/10	CX
16254	PARAF SEX ACO M 1X5 G5UNC BELENU C/10	CX
13018	PARAF SEX ACO M 1X5 RP G5UNC C/10	CX
17048	PARAF SEX ACO M 1X5.1/2 G5 UNC BELENU C/10	PT
25744	PARAF SEX ACO M 1X5.1/2 RP G5 C/010	CX
20252	PARAF SEX ACO M 1X6 G5UNC BELENU C/10	PT
13019	PARAF SEX ACO M 1X6 RP G5UNC C/10	CX
27270	PARAF SEX ACO M 1X6.1/2 G5UNC BEC/10	CX
25745	PARAF SEX ACO M 1X6.1/2 RP G5 C/010	CX
16255	PARAF SEX ACO M 1X7 G5UNC BELENU C/10	CX
13020	PARAF SEX ACO M 1X7 RP G5UNC C/10	CX
25746	PARAF SEX ACO M 1X7.1/2 RP G5 C/010	CX
13021	PARAF SEX ACO M 1X8 RP G5UNC C/10	CX
23323	PARAF SEX ACO M 1X9 G5UNC BEL C/10	CX
13819	PARAF SEX ACO MA 05X010 RI 8.8 BEL C/500	CX-5-CT
73	PARAF SEX ACO MA 05X010 RI 8.8 C/500	CX-5-CT
7608	PARAF SEX ACO MA 05X012 RI 8.8 C/500	CX-5-CT
14486	PARAF SEX ACO MA 05X016 RI 8.8 BEL C/500	CX-5-CT
7772	PARAF SEX ACO MA 05X016 RI 8.8 C/500	CX-5-CT
13821	PARAF SEX ACO MA 05X020 RI 8.8 BEL C/500	CX-5-CT
7609	PARAF SEX ACO MA 05X020 RI 8.8 C/500	CX-5-CT
13310	PARAF SEX ACO MA 05X025 RI 8.8 BEL C/500	CX-5-CT
7612	PARAF SEX ACO MA 05X025 RI 8.8 C/500	CX-5-CT
14487	PARAF SEX ACO MA 05X030 RI 8.8 BEL C/500	CX-5-CT
7613	PARAF SEX ACO MA 05X030 RI 8.8 C/500	CX-5-CT
7616	PARAF SEX ACO MA 05X035 RI 8.8 C/500	CX-5-CT
13311	PARAF SEX ACO MA 05X040 RI 8.8 BEL C/500	CX-5-CT
7628	PARAF SEX ACO MA 05X040 RI 8.8 C/500	CX-5-CT



Belenus



**O MELHOR E MAIS COMPLETO MIX DE
FIXADORES E FERRAGENS
DO MERCADO BRASILEIRO**

WWW.BELENUS.COM.BR



FÁBRICA - VINHEDO

UNIDADES

Centro de Distribuição

São paulo

3 Centros de Distribuição - Vinhedo

Centro de Distribuição - Itupeva

Espírito Santo

Centro de Distribuição - Viana

Pernambuco

Centro de Distribuição - Paulista

Rio Grande do Sul

Centro de Distribuição - Caxias do Sul

Fábricas

São paulo

Fábrica - Vinhedo

Fábrica - Monte M

Minas Gerais

Fábrica - Cambuí



FIXADORES

PARAFUSO SEXTAVADO - AÇO (POL/MM)

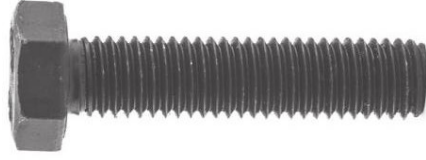

RI - Rosca Inteira



RP - Rosca Parcial

CÓD.	DESCRIÇÃO	EMB.
16261	PARAF SEX ACO MA 08X025 R188 BEC/200	CX-2-CT
9821	PARAF SEX ACO MA 08X030 RI 8.8 C/200	CX-2-CT
16262	PARAF SEX ACO MA 08X030 RI 8.8BEC/200	CX-2-CT
9822	PARAF SEX ACO MA 08X035 RI 8.8 C/200	CX-2-CT
2275	PARAF SEX ACO MA 08X035 RI 8.8BEC/150	CX-1,5-CT
9823	PARAF SEX ACO MA 08X040 RI 8.8 C/200	CX-2-CT
846	PARAF SEX ACO MA 08X040 RI 8.8BEC/150	CX-1,5-CT
16264	PARAF SEX ACO MA 08X040 RI 8.8BEC/200	CX-2-CT
9824	PARAF SEX ACO MA 08X045 RI 8.8 C/200	CX-2-CT
852	PARAF SEX ACO MA 08X045 RI 8.8BEC/100	CX-1-CT
10237	PARAF SEX ACO MA 08X050 RI 8.8 C/200	CX-2-CT
860	PARAF SEX ACO MA 08X050 RI 8.8BEC/100	CX-1-CT
10238	PARAF SEX ACO MA 08X060 RP 8.8 C/100	CX-1-CT
16267	PARAF SEX ACO MA 08X060 RP 8.8BEC/100	CX-1-CT
10239	PARAF SEX ACO MA 08X070 RP 8.8 C/100	CX-1-CT
16268	PARAF SEX ACO MA 08X070 RP 8.8BEC/100	CX-1-CT
10240	PARAF SEX ACO MA 08X080 RP 8.8 C/100	CX-1-CT
16269	PARAF SEX ACO MA 08X080 RP 8.8BEC/100	CX-1-CT
10241	PARAF SEX ACO MA 08X090 RP 8.8 C/100	CX-1-CT
16271	PARAF SEX ACO MA 08X090 RP 8.8BEC/100	CX-1-CT
21544	PARAF SEX ACO MA 08X095 RP 8.8 C/050	CX
10244	PARAF SEX ACO MA 08X100 RP 8.8 C/050	CX
16272	PARAF SEX ACO MA 08X100 RP 8.8BEC/100	CX-1-CT
13319	PARAF SEX ACO MA 08X110 RP 8.8 BEL C/100	CX-1-CT
7824	PARAF SEX ACO MA 08X110 RP 8.8 C/020	CX
18061	PARAF SEX ACO MA 08X120 RP 8.8 C/020	CX
20753	PARAF SEX ACO MA 08X120 RP 8.8BEC/100	CX-1-CT
25752	PARAF SEX ACO MA 10X016 RI 8.8 C/100	CX-2-CT
9826	PARAF SEX ACO MA 10X020 RI 8.8 C/100	CX-1-CT
2094	PARAF SEX ACO MA 10X020 RI 8.8BEC/150	CX-1,5-CT
9827	PARAF SEX ACO MA 10X025 RI 8.8 C/100	CX-1-CT
3731	PARAF SEX ACO MA 10X025 RI 8.8BEC/100	CX-1-CT
9828	PARAF SEX ACO MA 10X030 RI 8.8 C/100	CX-1-CT
15806	PARAF SEX ACO MA 10X030 RI 8.8BEC/100	CX-1-CT
9829	PARAF SEX ACO MA 10X035 RI 8.8 C/100	CX-1-CT
15807	PARAF SEX ACO MA 10X035 RI 8.8BEC/100	CX-1-CT
29027	PARAF SEX ACO MA 10X040 RI 8.8 C/100	CX-1-CT
15808	PARAF SEX ACO MA 10X040 RI 8.8BEC/100	CX-1-CT
9831	PARAF SEX ACO MA 10X045 RI 8.8 C/100	CX-1-CT
845	PARAF SEX ACO MA 10X045 RI 8.8BEC/75	CX-0,75-CT
9832	PARAF SEX ACO MA 10X050 RI 8.8 C/100	CX-1-CT
710	PARAF SEX ACO MA 10X050 RI 8.8 C/100...	CX-1-CT
2278	PARAF SEX ACO MA 10X050 RI 8.8BEC/50	CX
10245	PARAF SEX ACO MA 10X060 RP 8.8 C/100	CX-1-CT
16515	PARAF SEX ACO MA 10X060 RP 8.8BEC/100	CX-1-CT
10246	PARAF SEX ACO MA 10X070 RP 8.8 C/100	CX-1-CT
16516	PARAF SEX ACO MA 10X070 RP 8.8BEC/100	CX-1-CT
10247	PARAF SEX ACO MA 10X080 RP 8.8 C/100	CX-1-CT
794	PARAF SEX ACO MA 10X080 RP 8.8 C/100...	CX-1-CT
16275	PARAF SEX ACO MA 10X080 RP 8.8BEC/100	CX-1-CT
10248	PARAF SEX ACO MA 10X090 RP 8.8 C/100	CX-1-CT
10249	PARAF SEX ACO MA 10X100 RP 8.8 C/050	CX
16277	PARAF SEX ACO MA 10X100 RP 8.8BEC C/50	CX
19445	PARAF SEX ACO MA 10X110 RP 8.8 C/050	CX
16517	PARAF SEX ACO MA 10X110 RP 8.8BEC/50	CX
16750	PARAF SEX ACO MA 10X120 RP 8.8 C/050	CX
16519	PARAF SEX ACO MA 10X120 RP 8.8BEC/50	CX
25756	PARAF SEX ACO MA 10X130 RP 8.8 C/050	CX
27189	PARAF SEX ACO MA 10X130 RP 8.8BEC/50	CX
25757	PARAF SEX ACO MA 10X140 RP 8.8 C/050	CX
25758	PARAF SEX ACO MA 10X150 RP 8.8 C/050	CX
25759	PARAF SEX ACO MA 12X020 RI 8.8 C/200	CX-2-CT
17704	PARAF SEX ACO MA 12X025 RI 8.8 C/100	CX-1-CT
17578	PARAF SEX ACO MA 12X025 RI 8.8BEC/100	CX-1-CT
9833	PARAF SEX ACO MA 12X030 RI 8.8 C/100	CX-1-CT
848	PARAF SEX ACO MA 12X035 RI 8.8BEC/50	CX-0,5-CT
9834	PARAF SEX ACO MA 12X035 RI 8.8 C/100	CX-1-CT
859	PARAF SEX ACO MA 12X035 RI 8.8BEC/50	CX-0,5-CT
13320	PARAF SEX ACO MA 12X040 RI 8.8 BEL C/50	CX
29028	PARAF SEX ACO MA 12X040 RI 8.8 C/100	CX-1-CT
9835	PARAF SEX ACO MA 12X040 RI 8.8 C/100	CX-1-CT
10251	PARAF SEX ACO MA 12X045 RI 8.8 C/100	CX-1-CT
863	PARAF SEX ACO MA 12X045 RI 8.8BEC/50	CX-0,5-CT
10253	PARAF SEX ACO MA 12X050 RI 8.8 C/100	CX-1-CT
795	PARAF SEX ACO MA 12X050 RI 8.8 C/100...	CX-1-CT
851	PARAF SEX ACO MA 12X050 RI 8.8BEC/50	CX-0,5-CT
25767	PARAF SEX ACO MA 12X055 RP 8.8 C/050	CX
10254	PARAF SEX ACO MA 12X060 RP 8.8 C/050	CX
16278	PARAF SEX ACO MA 12X060 RP 8.8BEC/50	CX
25768	PARAF SEX ACO MA 12X065 RP 8.8 C/050	CX
27191	PARAF SEX ACO MA 12X065 RP 8.8BEC/50	CX
10255	PARAF SEX ACO MA 12X070 RP 8.8 C/050	CX

CÓD.	DESCRIÇÃO	EMB.
16279	PARAF SEX ACO MA 12X070 RP 8.8BEC/50	CX
10256	PARAF SEX ACO MA 12X080 RP 8.8 C/050	CX
16518	PARAF SEX ACO MA 12X080 RP 8.8BEC/50	CX
10257	PARAF SEX ACO MA 12X090 RP 8.8 C/050	CX
10258	PARAF SEX ACO MA 12X100 RP 8.8 C/050	CX
16521	PARAF SEX ACO MA 12X100 RP 8.8BEC/50	CX
14505	PARAF SEX ACO MA 12X110 RP 8.8 BEL C/50	CX
3641	PARAF SEX ACO MA 12X110 RP 8.8 C/050	CX
17819	PARAF SEX ACO MA 12X120 RP 8.8 C/050	CX
16319	PARAF SEX ACO MA 12X120 RP 8.8BEC/50	CX
25764	PARAF SEX ACO MA 12X130 RP 8.8 C/050	CX
27271	PARAF SEX ACO MA 12X130 RP 8.8BEC/50	CX
25765	PARAF SEX ACO MA 12X140 RP 8.8 C/050	CX
25766	PARAF SEX ACO MA 12X150 RP 8.8 C/050	CX
27168	PARAF SEX ACO MA 14X025 RI 8.8BEC/100	CT
25761	PARAF SEX ACO MA 14X030 RI 8.8 C/100	CT
27477	PARAF SEX ACO MA 14X030 RI 8.8BEC/100	CT
9836	PARAF SEX ACO MA 14X035 RI 8.8 C/100	CX-1-CT
16283	PARAF SEX ACO MA 14X035 RI 8.8BENU	CX-1-CT
9837	PARAF SEX ACO MA 14X040 RI 8.8 C/100	CX-1-CT
16522	PARAF SEX ACO MA 14X040 RI 8.8BEC/100	CX-1-CT
9838	PARAF SEX ACO MA 14X045 RI 8.8 C/050	CX
16284	PARAF SEX ACO MA 14X045 RI 8.8BEC/50	CX
10259	PARAF SEX ACO MA 14X050 RI 8.8 C/050	CX-1-CT
16285	PARAF SEX ACO MA 14X050 RI 8.8BEC/50	CX
10260	PARAF SEX ACO MA 14X060 RP 8.8 C/050	CX
16523	PARAF SEX ACO MA 14X060 RP 8.8BEC/50	CX
10261	PARAF SEX ACO MA 14X070 RP 8.8 C/050	CX
16286	PARAF SEX ACO MA 14X070 RP 8.8BEC/50	CX
15581	PARAF SEX ACO MA 14X080 RP 8.8 C/050	CX-1,5-CT
16287	PARAF SEX ACO MA 14X080 RP 8.8BEC/50	CX
11902	PARAF SEX ACO MA 14X100 RP 8.8 C/050	CX
20752	PARAF SEX ACO MA 14X100 RP 8.8BEC/50	CX
18799	PARAF SEX ACO MA 14X110 RP 8.8 C/050	CX
25769	PARAF SEX ACO MA 14X120 RP 8.8 C/050	CX
27594	PARAF SEX ACO MA 14X120 RP 8.8BEC/50	CX
14517	PARAF SEX ACO MA 14X130 RP 8.8 BEL C/50	CX
25770	PARAF SEX ACO MA 14X130 RP 8.8 C/050	CX
25771	PARAF SEX ACO MA 14X140 RP 8.8 C/025	CX
27193	PARAF SEX ACO MA 14X140 RP 8.8BEC/20	CX
25772	PARAF SEX ACO MA 14X150 RP 8.8 C/025	CX
27194	PARAF SEX ACO MA 14X150 RP 8.8BEC/20	CX
25762	PARAF SEX ACO MA 16X025 RI 8.8 C/050	CX
13022	PARAF SEX ACO MA 16X030 RI 8.8 C/050	CX
16288	PARAF SEX ACO MA 16X030 RI 8.8BEC/50	CX
13322	PARAF SEX ACO MA 16X035 RI 8.8 BEL C/50	CX-1-CT
23993	PARAF SEX ACO MA 16X035 RI 8.8 C/050	CX-1-CT
13023	PARAF SEX ACO MA 16X040 RI 8.8 C/050	CX-1-CT
16289	PARAF SEX ACO MA 16X040 RI 8.8BEC/50	CX-1-CT
25763	PARAF SEX ACO MA 16X045 RI 8.8 C/050	CX-1-CT
27169	PARAF SEX ACO MA 16X045 RI 8.8BEC/50	CX-1-CT
13024	PARAF SEX ACO MA 16X050 RI 8.8 C/050	CX
16290	PARAF SEX ACO MA 16X050 RI 8.8BEC/50	CX
13025	PARAF SEX ACO MA 16X060 RP 8.8 C/050	CX
16292	PARAF SEX ACO MA 16X060 RP 8.8BEC/50	CX
13026	PARAF SEX ACO MA 16X070 RP 8.8 C/050	CX
16296	PARAF SEX ACO MA 16X070 RP 8.8BEC/50	CX
6307	PARAF SEX ACO MA 16X075 RP 8.8 C/050	CX
13027	PARAF SEX ACO MA 16X080 RP 8.8 C/050	CX
16293	PARAF SEX ACO MA 16X080 RP 8.8BEC/50	CX
10262	PARAF SEX ACO MA 16X090 RP 8.8 C/050	CX
16299	PARAF SEX ACO MA 16X090 RP 8.8BEC/50	CX
10263	PARAF SEX ACO MA 16X100 RP 8.8 C/050	CX
16524	PARAF SEX ACO MA 16X100 RP 8.8BEC/50	CX
1612	PARAF SEX ACO MA 16X110 RP 8.8BELC/20	CX
11379	PARAF SEX ACO MA 16X110 RP 8.8 C/020	CX
25773	PARAF SEX ACO MA 16X120 RP 8.8 C/020	CX
27600	PARAF SEX ACO MA 16X120 RP 8.8BEC/20	CX
713	PARAF SEX ACO MA 16X130 RP 8.8 C/020...	CX
27599	PARAF SEX ACO MA 16X130 RP 8.8BEC/20	CX
25775	PARAF SEX ACO MA 16X140 RP 8.8 C/020	CX
27597	PARAF SEX ACO MA 16X140 RP 8.8BEC/20	CX
25776	PARAF SEX ACO MA 16X150 RP 8.8 C/020	CX
714	PARAF SEX ACO MA 16X150 RP 8.8 C/020...	CX
27598	PARAF SEX ACO MA 16X150 RP 8.8BEC/20	CX
11370	PARAF SEX ACO MA 16X160 RP 8.8 C/050	CX-1-CT
27829	PARAF SEX ACO MA 16X180 RP 8.8BEC/20	CX
6395	PARAF SEX ACO MA 18X030 RI 8.8 C/050	CX
6417	PARAF SEX ACO MA 18X040 RI 8.8 C/050	CX
6418	PARAF SEX ACO MA 18X045 RI 8.8 C/050	CX
6419	PARAF SEX ACO MA 18X050 RI 8.8 C/050	CX
6420	PARAF SEX ACO MA 18X060 RP 8.8 C/050	CX

CÓD.	DESCRIÇÃO	EMB.
6421	PARAF SEX ACO MA 18X070 RP 8.8 C/050	CX
6423	PARAF SEX ACO MA 18X080 RP 8.8 C/050	CX
6424	PARAF SEX ACO MA 18X090 RP 8.8 C/050	CX
6378	PARAF SEX ACO MA 18X100 RP 8.8 C/050	CX
6379	PARAF SEX ACO MA 18X110 RP 8.8 C/050	CX
6381	PARAF SEX ACO MA 18X120 RP 8.8 C/050	CX
6382	PARAF SEX ACO MA 18X130 RP 8.8 C/050	CX
6383	PARAF SEX ACO MA 18X140 RP 8.8 C/050	CX
6384	PARAF SEX ACO MA 18X150 RP 8.8 C/050	CX
6385	PARAF SEX ACO MA 18X160 RP 8.8 C/050	CX
6393	PARAF SEX ACO MA 18X170 RP 8.8 C/050	CX
6394	PARAF SEX ACO MA 18X180 RP 8.8 C/050	CX
20235	PARAF SEX ACO MA 20X030 RI 8.8 C/050	CX
6460	PARAF SEX ACO MA 20X040 RI 8.8 C/050	CX
6462	PARAF SEX ACO MA 20X050 RI 8.8 C/050	CX
11387	PARAF SEX ACO MA 20X060 RP 8.8 C/050	CX
6473	PARAF SEX ACO MA 20X070 RP 8.8 C/050	CX
6475	PARAF SEX ACO MA 20X080 RP 8.8 C/050	CX
6476	PARAF SEX ACO MA 20X090 RP 8.8 C/050	CX
6425	PARAF SEX ACO MA 20X100 RP 8.8 C/050	CX
6426	PARAF SEX ACO MA 20X110 RP 8.8 C/050	CX
6437	PARAF SEX ACO MA 20X120 RP 8.8 C/050	CX
6438	PARAF SEX ACO MA 20X130 RP 8.8 C/050	CX
6439	PARAF SEX ACO MA 20X140 RP 8.8 C/050	CX
6440	PARAF SEX ACO MA 20X150 RP 8.8 C/050	CX
6441	PARAF SEX ACO MA 20X160 RP 8.8 C/050	CX
6444	PARAF SEX ACO MA 20X170 RP 8.8 C/050	CX
6459	PARAF SEX ACO MA 20X180 RP 8.8 C/050	CX
11297	PARAF SEX ACO MA 22X050 RI 8.8 C/050	CX
28266	PARAF SEX ACO MA 22X060 RP 8.8 C/050	CX
11300	PARAF SEX ACO MA 22X070 RP 8.8 C/050	CX
11309	PARAF SEX ACO MA 22X080 RP 8.8 C/050	CX
11314	PARAF SEX ACO MA 22X090 RP 8.8 C/050	CX
11318	PARAF SEX ACO MA 22X100 RP 8.8 C/050	CX
11317	PARAF SEX ACO MA 22X110 RP 8.8 C/050	CX
11334	PARAF SEX ACO MA 22X120 RP 8.8 C/050	CX
11337	PARAF SEX ACO MA 22X130 RP 8.8 C/050	CX
11339	PARAF SEX ACO MA 22X140 RP 8.8 C/050	CX
11340	PARAF SEX ACO MA 22X150 RP 8.8 C/050	CX
11345	PARAF SEX ACO MA 24X080 RP 8.8 C/050	CX
11350	PARAF SEX ACO MA 24X100 RP 8.8 C/050	CX
11353	PARAF SEX ACO MA 24X110 RP 8.8 C/050	CX
11360	PARAF SEX ACO MA 24X120 RP 8.8 C/050	CX
11362	PARAF SEX ACO MA 24X130 RP 8.8 C/050	CX
11364	PARAF SEX ACO MA 24X150 RP 8.8 C/050	CX
11367	PARAF SEX ACO MA 24X180 RP 8.8 C/050	CX
11369	PARAF SEX ACO MA 24X200 RP 8.8 C/050	CX
24281	PARAF SEX ACO MB 10X050 RP 8.8 C/100	CT
22352	PARAF SEX ACO MB 10X060 RP 8.8 C/100	CX
22353	PARAF SEX ACO MB 10X070 RP 8.8 C/100	CX
25781	PARAF SEX ACO MB 12X025 RI 8.8 C/100	CT
10277	PARAF SEX ACO MB 12X030 RI 8.8 C/100	CX-1-CT
10278	PARAF SEX ACO MB 12X035 RI 8.8 C/100	CX-1-CT
10279	PARAF SEX ACO MB 12X040 RI 8.8 C/100	CX-1-CT
10280	PARAF SEX ACO MB 12X045 RI 8.8 C/100	CX-1-CT
10281	PARAF SEX ACO MB 12X050 RI 8.8 C/100	CX-1-CT
25786	PARAF SEX ACO MB 12X055 RP 8.8 C/050	CX
10282	PARAF SEX ACO MB 12X060 RP 8.8 C/050	CX
10284	PARAF SEX ACO MB 12X080 RP 8.8 C/050	CX
10285	PARAF SEX ACO MB 12X090 RP 8.8 C/050	CX
10286	PARAF SEX ACO MB 12X100 RP 8.8 C/050	CX
25785	PARAF SEX ACO MB 12X120 RP 8.8 C/050	CX
25787	PARAF SEX ACO MB 14X025 RI 8.8 C/100	CT
10287	PARAF SEX ACO MB 14X030 RI 8.8 C/100	CX-1-CT
10288	PARAF SEX ACO MB 14X035 RI 8.8 C/100	CX-1-CT
10289	PARAF SEX ACO MB 14X040 RI 8.8 C/100	CX-1-CT
26974	PARAF SEX ACO MB 14X045 RI 8.8 C/050	CX
10291	PARAF SEX ACO MB 14X050 RP 8.8 C/050	CX
10292	PARAF SEX ACO MB 14X060 RP 8.8 C/050	CX
10293	PARAF SEX ACO MB 14X070 RP 8.8 C/050	CX
10294	PARAF SEX ACO MB 14X080 RP 8.8	

PARAFUSO SEXTAVADO - FERRO



Zincado



Poído

CÓD.	DESCRIÇÃO	EMB.
12488	PARAF SEX FERR AA 1/4X1/2 BELE C/500	CX-5-CT
4124	PARAF SEX FERR AA 1/4X1/2 CISE C/500	CX-5-CT
183	PARAF SEX FERR AA 1/4X1/2 CISE C/500...	CX-5-CT
16527	PARAF SEX FERR AA 1/4X1/2ZN BE C/500	CX-5-CT
182	PARAF SEX FERR AA 1/4X1/2ZN CI C/500...	CX-5-CT
13823	PARAF SEX FERR AB 1/4X5/8 BEL ZB C/500	CX-5-CT
12644	PARAF SEX FERR AB 1/4X5/8 BELENC/500	CX-5-CT
4125	PARAF SEX FERR AB 1/4X3/4 CISE C/500	CX-5-CT
12489	PARAF SEX FERR AC 1/4X3/4 BELE C/500	CX-5-CT
4126	PARAF SEX FERR AC 1/4X3/4 CISE C/500	CX-5-CT
16321	PARAF SEX FERR AC 1/4X3/4 ZI BEC/500	CX-5-CT
6099	PARAF SEX FERR AC 1/4X3/4 ZN C/500	CX-5-CT
12490	PARAF SEX FERR AC 1/4X7/8 BELE C/500	CX-5-CT
4127	PARAF SEX FERR AC 1/4X7/8 CISE C/500	CX-5-CT
19973	PARAF SEX FERR AC 1/4X7/8 ZIN BELENU	CX-5-CT
3690	PARAF SEX FERR AE 1/4X1 BELENU C/250	CX-2,5-CT
4128	PARAF SEX FERR AE 1/4X1 CISER C/500	CX-5-CT
3740	PARAF SEX FERR AE 1/4X1 ZIN BELC/250	CX-2,5-CT
9844	PARAF SEX FERR AE 1/4X1ZIN C/500	CX-5-CT
12492	PARAF SEX FERR AF 1/4X1.1/4 BELC/200	CX-2-CT
4129	PARAF SEX FERR AF 1/4X1.1/4 CI C/200	CX-2-CT
19773	PARAF SEX FERR AF 1/4X1.1/4 ZINC BELC/200	CX-2-CT
16751	PARAF SEX FERR AF 1/4X1.1/4 ZN C/200	CX-2-CT
12645	PARAF SEX FERR AG 1/4X1.1/2 BELC/200	CX-2-CT
4130	PARAF SEX FERR AG 1/4X1.1/2 CI C/200	CX-2-CT
12515	PARAF SEX FERR AG 1/4X1.1/2 ZIBC/200	CX-2-CT
9845	PARAF SEX FERR AG 1/4X1.1/2 ZIN C/200	CX-2-CT
12990	PARAF SEX FERR AH 1/4X1.3/4 BELC/200	CX-2-CT
4131	PARAF SEX FERR AH 1/4X1.3/4 CI C/200	CX-2-CT
4132	PARAF SEX FERR AI 1/4X2 CISER C/200	CX-2-CT
843	PARAF SEX FERR AI 1/4X2 RI BEL C/150	CX-1,5-CT
3320	PARAF SEX FERR AI 1/4X2 ZIN BELC/100	CX-1-CT
12510	PARAF SEX FERR AI 1/4X2 ZIN BELC/200	CX-2-CT
9846	PARAF SEX FERR AI 1/4X2 ZI BEL C/200	CX-2-CT
26271	PARAF SEX FERR AK 1/4X2.1/2 RIZI B/200	CX-2-CT
6412	PARAF SEX FERR AK 1/4X2.1/2 ZN C/200	CX-2-CT
25495	PARAF SEX FERR AK 1/4X2.1/2RI BEC/200	CX-2-CT
4136	PARAF SEX FERR AL 1/4X3 CISER C/200	CX-2-CT
12844	PARAF SEX FERR AL 1/4X3 SOP/BELC/100	CX-1-CT
13403	PARAF SEX FERR AM 1/4X3.1/2 BE C/100	CX-1-CT
13404	PARAF SEX FERR AN 1/4X4 BELENU C/100	CX-1-CT
4138	PARAF SEX FERR AN 1/4X4 CISER C/100	CX-1-CT
25412	PARAF SEX FERR AN 1/4X5 CISER C/100	CX-1-CT
20771	PARAF SEX FERR BA 5/16X1.1/2 BELEC/500	CX-5-CT
4139	PARAF SEX FERR BA 5/16X1.1/2 C/500	CX-5-CT
4140	PARAF SEX FERR BA 5/16X5/8 C/500	CX-5-CT
854	PARAF SEX FERR BB 5/16X5/8 RI BEL C/250	CX-2,5-CT
3248	PARAF SEX FERR BB 5/16X5/8 ZIN BEL C/250	CX-2,5-CT
12646	PARAF SEX FERR BC 5/16X3/4 BELEC/200	CX-2-CT
29029	PARAF SEX FERR BC 5/16X3/4 C/500	CX-2-CT
16699	PARAF SEX FERR BC 5/16X3/4 ZIN SO/BE	CX-2-CT
15761	PARAF SEX FERR BC 5/16X3/4 ZN C/200	CX-2-CT
12503	PARAF SEX FERR BD 5/16X7/8 BEL C/200	CX-2-CT
15213	PARAF SEX FERR BD 5/16X7/8 BEL ZB C/200	CX-2-CT
12500	PARAF SEX FERR BE 5/16X1 BELEN C/200	CX-2-CT
4143	PARAF SEX FERR BE 5/16X1 CISER C/200	CX-2-CT
12516	PARAF SEX FERR BE 5/16X1 ZIN BEC/200	CX-2-CT
9839	PARAF SEX FERR BE 5/16X1 ZIN C/200	CX-2-CT
12504	PARAF SEX FERR BF 5/16X1.1/4 BEC/200	CX-2-CT
4144	PARAF SEX FERR BF 5/16X1.1/4 CI C/200	CX-2-CT
20777	PARAF SEX FERR BF 5/16X1.1/4ZIBC/200	CX-2-CT
12499	PARAF SEX FERR BG 5/16X1.1/2 BEC/150	CX-1,5-CT
4145	PARAF SEX FERR BG 5/16X1.1/2 C/200	CX-2-CT
12511	PARAF SEX FERR BG 5/16X1.1/2ZI SO/BE	CX-2-CT
9841	PARAF SEX FERR BG 5/16X1.1/2ZN C/200	CX-2-CT
4146	PARAF SEX FERR BH 5/16X1.3/4 C/200	CX-2-CT
2093	PARAF SEX FERR BH 5/16X1.3/4 RI BEC/150	CX-1,5-CT
4147	PARAF SEX FERR BI 5/16X2 C/500	CX-2-CT
2101	PARAF SEX FERR BI 5/16X2 RI BELC/100	CX-1-CT
3745	PARAF SEX FERR BI 5/16X2 ZIN BEC/100	CX-1-CT
9842	PARAF SEX FERR BI 5/16X2 ZN CI C/200	CX-2-CT
4149	PARAF SEX FERR BK 5/16X2.1/2 CI C/100	CX-1-CT
25496	PARAF SEX FERR BK 5/16X2.1/2RI BC/100	CX-1-CT
26267	PARAF SEX FERR BK 5/16X2.1/2ZB BC/100	CX-1-CT
18984	PARAF SEX FERR BK 5/16X2.1/2ZN C/100	CX-1-CT
4151	PARAF SEX FERR BL 5/16X3 C/500	CX-1-CT
25497	PARAF SEX FERR BL 5/16X3 RI BELC/100	CX-1-CT
16680	PARAF SEX FERR BL 5/16X3 RI ZI BELC/100	CX-1-CT

CÓD.	DESCRIÇÃO	EMB.
53	PARAF SEX FERR BL 5/16X3 RP ZI BELC/100	CX-1-CT
17708	PARAF SEX FERR BL 5/16X3 ZN CI C/100	CX-1-CT
13282	PARAF SEX FERR BM 5/16X3.1/2 BEC/100	CX-1-CT
4152	PARAF SEX FERR BM 5/16X3.1/2CI C/100	CX-1-CT
13408	PARAF SEX FERR BN 5/16X4 BELEN C/100	CX-1-CT
4153	PARAF SEX FERR BN 5/16X4 CISER C/100	CX-1-CT
6012	PARAF SEX FERR BN 5/16X4 ZIN BEL/JOM C/100	CX-1-CT
16528	PARAF SEX FERR BO 5/16X5.1/2 BEC/100	CX-1-CT
4154	PARAF SEX FERR BO 5/16X4.1/2 C/100	CX-1-CT
16529	PARAF SEX FERR BP 5/16X5 CISER C/100	CX-1-CT
4155	PARAF SEX FERR BP 5/16X5 C/100	CX-1-CT
19772	PARAF SEX FERR BQ 5/16X5.1/2 BEC/100	CX-1-CT
9636	PARAF SEX FERR BQ 5/16X5.1/2 C/100	CX-1-CT
27205	PARAF SEX FERR BQ 5/16X6 BEL C/100	CT
25810	PARAF SEX FERR BR 5/16X6 CISER C/100	CT
25791	PARAF SEX FERR CA 3/8X1/2 CISE C/200	CX-2-CT
27566	PARAF SEX FERR CB 3/8X5/8 BEL C/200	CX-2-CT
4158	PARAF SEX FERR CC 3/8X3/4 CISE C/200	CX-2-CT
12506	PARAF SEX FERR CC 3/8X3/4 SO/BEC/200	CX-2-CT
12507	PARAF SEX FERR CD 3/8X7/8 BELE C/200	CX-2-CT
4159	PARAF SEX FERR CD 3/8X7/8 BELE C/200	CX-2-CT
3321	PARAF SEX FERR CE 3/8X1 BELEN C/100	CX-1-CT
4160	PARAF SEX FERR CE 3/8X1 CISER C/200	CX-2-CT
23136	PARAF SEX FERR CE 3/8X1 RI BEL ZB C/200	CX-2-CT
4465	PARAF SEX FERR CF 3/8X1.1/4 BELC/150	CX-1,5-CT
16835	PARAF SEX FERR CG 3/8X1.1/2 BEL ZB C/100	CX-1-CT
3319	PARAF SEX FERR CG 3/8X1.1/2 BEL C/200	CX-1-CT
29205	PARAF SEX FERR CG 3/8X1.1/2 ZI C/200	CX-2-CT
4162	PARAF SEX FERR CH 3/8X1.1/2 CI C/200	CX-2-CT
2102	PARAF SEX FERR CH 3/8X1.1/2 BELC/100	CX-1-CT
13116	PARAF SEX FERR CH 3/8X1.3/4 BELC/200	CX-2-CT
4164	PARAF SEX FERR CI 3/8X2 CISER C/200	CX-2-CT
23067	PARAF SEX FERR CI 3/8X2 C/500	CX-2-CT
21953	PARAF SEX FERR CI 3/8X2 RI BEL ZB C/200	CX-2-CT
2105	PARAF SEX FERR CI 3/8X2 RI BELC/100	CX-1-CT
4166	PARAF SEX FERR CK 3/8X2.1/2 CI C/100	CX-1-CT
25609	PARAF SEX FERR CK 3/8X2.1/2 RI BC/100	CX-1-CT
17052	PARAF SEX FERR CL 3/8X2.1/2 RI ZB BEL C/100	CX-1-CT
4168	PARAF SEX FERR CL 3/8X3 CISER C/200	CX-1-CT
16837	PARAF SEX FERR CL 3/8X3 RI BEL ZB C/100	CX-1-CT
13339	PARAF SEX FERR CL 3/8X3 RI BELC/100	CX-1-CT
4169	PARAF SEX FERR CM 3/8X3.1/2 CI C/100	CX-1-CT
13225	PARAF SEX FERR CM 3/8X3.1/2 SOP/BELE	CX-1-CT
13226	PARAF SEX FERR CN 3/8X4 BELENU C/100	CX-1-CT
16839	PARAF SEX FERR CN 3/8X4 BELENU ZB C/100	CX-1-CT
4170	PARAF SEX FERR CO 3/8X4 CISER C/100	CX-1-CT
16328	PARAF SEX FERR CO 3/8X4.1/2 BELEC/50	CX
4171	PARAF SEX FERR CO 3/8X5.1/2 C/500	CX
16530	PARAF SEX FERR CP 3/8X5 BELENU C/50	CX
4172	PARAF SEX FERR CP 3/8X5 CISER C/50	CX
16331	PARAF SEX FERR CP 3/8X5.1/2 BELEC/50	CX
9482	PARAF SEX FERR CP 3/8X5.1/2 C/500	CX
16332	PARAF SEX FERR CR 3/8X6 BELENU C/50	CX
15579	PARAF SEX FERR CR 3/8X6 CISER C/50	CX
16531	PARAF SEX FERR DA 7/16X1 BELEN C/200	CX-2-CT
4173	PARAF SEX FERR DA 7/16X1 CISER C/200	CX-2-CT
4174	PARAF SEX FERR DB 7/16X1.1/4 C/200	CX-2-CT
16532	PARAF SEX FERR DB 7/16X1.1/4 BEC/100	CX-1-CT
4175	PARAF SEX FERR DC 7/16X1.1/2CI C/100	CX-1-CT
16533	PARAF SEX FERR DE 7/16X2 BELEN C/100	CX-1-CT
4177	PARAF SEX FERR DE 7/16X2 CISER C/100	CX-1-CT
16534	PARAF SEX FERR DF 7/16X2.1/2 BEC/100	CX-1-CT
4179	PARAF SEX FERR DF 7/16X2.1/2CI C/100	CX-1-CT
16535	PARAF SEX FERR DG 7/16X3 BELEN C/100	CX-1-CT
4180	PARAF SEX FERR DG 7/16X3 CISER C/100	CX-1-CT
4181	PARAF SEX FERR DH 7/16X3.1/2 CI C/50	CX
4182	PARAF SEX FERR DI 7/16X4 CISER C/50	CX
2277	PARAF SEX FERR EA 1/2X1 BEL C/50	CX
4185	PARAF SEX FERR EA 1/2X1 CISER C/100	CX-1-CT
16538	PARAF SEX FERR EB 1/2X1.1/4 BELC/100	CX-1-CT
4186	PARAF SEX FERR EB 1/2X1.1/4 CI C/100	CX-1-CT
4187	PARAF SEX FERR EC 1/2X1.1/2 CI C/100	CX-1-CT
16841	PARAF SEX FERR EC 1/2X1.1/2 RI BEL ZB C/50	CX-0,5-CT
847	PARAF SEX FERR EC 1/2X1.1/2 RI BELC/50	CX-0,5-CT
2562	PARAF SEX FERR ED 1/2X1.3/4 BELENU C/50	CX
2097	PARAF SEX FERR EE 1/2X2 BELENU RI C/50	CX
21207	PARAF SEX FERR EE 1/2X2 BELENU RI ZB C/100	CX-1-CT
4189	PARAF SEX FERR EE 1/2X2 CISER C/100	CX-1-CT

CÓD.	DESCRIÇÃO	EMB.
16343	PARAF SEX FERR EF 1/2X2.1/2 BEL C/50	CX
16844	PARAF SEX FERR EF 1/2X2.1/2 BEL ZB C/50	CX
4191	PARAF SEX FERR EF 1/2X2.1/2 C/500	CX
16827	PARAF SEX FERR EG 1/2X3 BEL C/50	CX
16849	PARAF SEX FERR EG 1/2X3 BEL ZB C/50	CX
4193	PARAF SEX FERR EG 1/2X3 CISER C/50	CX
16345	PARAF SEX FERR EH 1/2X3.1/2 BEL C/50	CX
4194	PARAF SEX FERR EH 1/2X3.1/2 C/500	CX
16346	PARAF SEX FERR EI 1/2X4 BELENU C/50	CX
4195	PARAF SEX FERR EI 1/2X4 CISER C/50	CX
16539	PARAF SEX FERR EJ 1/2X4.1/2 BEL C/50	CX
4196	PARAF SEX FERR EJ 1/2X4.1/2 C/500	CX
16347	PARAF SEX FERR EK 1/2X5 BELENU C/50	CX
4197	PARAF SEX FERR EK 1/2X5 CISER C/50	CX
16349	PARAF SEX FERR EL 1/2X6 BELENU C/50	CX
4199	PARAF SEX FERR EL 1/2X6 C/500	CX
27206	PARAF SEX FERR EL 1/2X6 BELC/50	CX
25792	PARAF SEX FERR EN 1/2X7 C/500	CX
27202	PARAF SEX FERR EA 5/8X1 BEL C/100	CT
16350	PARAF SEX FERR GA 5/8X1.1/2 BEL C/50	CX
4092	PARAF SEX FERR GA 5/8X1.1/2 C/500	CX
16540	PARAF SEX FERR GA 5/8X1.1/2 BEL C/50	CX
4215	PARAF SEX FERR GC 5/8X2 CISER C/50	CX
4217	PARAF SEX FERR GC 5/8X2 C/500	CX
16352	PARAF SEX FERR GF 5/8X3 BELENU C/20	CX
4218	PARAF SEX FERR GF 5/8X3 C/500	CX
16353	PARAF SEX FERR GG 5/8X3.1/2 BEL C/20	CX
4219	PARAF SEX FERR GG 5/8X3.1/2 C/500	CX
16354	PARAF SEX FERR GH 5/8X4 BELENU C/20	CX
4220	PARAF SEX FERR GH 5/8X4 CISER C/20	CX
4222	PARAF SEX FERR GI 5/8X4.1/2 C/500	CX
16356	PARAF SEX FERR GJ 5/8X5 BELENU C/20	CX
4223	PARAF SEX FERR GJ 5/8X5 C/500	CX
4224	PARAF SEX FERR GK 5/8X5.1/2 C/500	CX
16358	PARAF SEX FERR GL 5/8X6 BELENU C/20	CX
4225	PARAF SEX FERR GL 5/8X6 C/500	CX
4226	PARAF SEX FERR GL 5/8X6.1/2 C/500	CX
16360	PARAF SEX FERR GM 5/8X7 BELENU C/20	CX
4227	PARAF SEX FERR GM 5/8X7 C/500	CX
4228	PARAF SEX FERR GN 5/8X8 C/500	CX
23297	PARAF SEX FERR GO 5/8X9 BELENU C/20	CX
15000	PARAF SEX FERR GO 5/8X9 C/500	CX
16362	PARAF SEX FERR GP 5/8X10 BELENU C/20	CX
15001	PARAF SEX FERR GP 5/8X10 C/500	CX
14586	PARAF SEX FERR HA 3/4X1.1/2 C/500	CX
17579	PARAF SEX FERR HA 3/4X2 BELENU C/50	CX
4232	PARAF SEX FERR HA 3/4X2 C/500	CX
4233	PARAF SEX FERR HB 3/4X2.1/2 C/500	CX
16365	PARAF SEX FERR HC 3/4X3 BELENU C/20	CX
4234	PARAF SEX FERR HC 3/4X3 C/500	CX
16367	PARAF SEX FERR HD 3/4X3.1/2 BEL C/20	CX
4235	PARAF SEX FERR HD 3/4X3.1/2 C/500	CX
16368	PARAF SEX FERR HE 3/4X4 BELENU C/20	CX
4236	PARAF SEX FERR HE 3/4X4 C/500	CX
4237	PARAF SEX FERR HF 3/4X4.1/2 C/500	CX
16369	PARAF SEX FERR HG 3/4X5 BELENU C/20	CX
4238	PARAF SEX FERR HG 3/4X5 C/500	CX
16370	PARAF SEX FERR HG 3/4X5.1/2 BELC/20	CX
4239	PARAF SEX FERR HH 3/4X6 C/500	CX
16374	PARAF SEX FERR HH 3/4X6 BELENU C/20	CX
14566	PARAF SEX FERR IA 7/8X3 C/500	CX
14574	PARAF SEX FERR IA 7/8X3 C/100	CX
14575	PARAF SEX FERR JA 1X3.1/2 C/500	CX
14576	PARAF SEX FERR JA 1X4 C/500	CX
14577	PARAF SEX FERR JA 1X5 C/500	CX
14578	PARAF SEX FERR JA 1X6 C/500	CX
20776	PARAF SEX FERR 1A 3/16X1/2 BELEC/500	CX-5-CT
15572	PARAF SEX FERR 1A 3/16X1/2 C/500	CX-5-CT
24130	PARAF SEX FERR 1A 3/16X5/8 BEL C/500	CX-5-CT
20775	PARAF SEX FERR 2A 3/16X3/4 BELEC/500	CX-5-CT
19787	PARAF SEX FERR 3A 3/16X7/8 BEL C/500	CX-5-CT
19788	PARAF SEX FERR 4A 3/16X1 BELEN C/500	CX-5-CT
15576	PARAF SEX FERR 4A 3/16X1 C/500	CX-5-CT
3842	PARAF SEX FERR 4A 3/16X1.1/4 C/500	CX-5-CT
20773	PARAF SEX FERR 5A 3/16X1.1/2 BEC/500	CX-5-CT
8700	PARAF SEX FERR 5A 3/16X1.1/2 C/500	CX-5-CT
20772	PARAF SEX FERR 5A 3/16X2 BELENU	CX-2-CT
8701	PARAF SEX FERR 5A 3/16X2 C/500	CX-2-CT



DICA DO REI

PARAFUSO SEXTAVADO

PARAFUSO SEXTAVADO - ROSCA INTEIRA

É utilizado em máquinas e equipamentos industriais, estruturas metálicas, veículos, móveis de aço e aplicações diversas.

O comprimento total não inclui a cabeça. É fornecido sem acabamento superficial.

Escala 1:1
Tamanho real

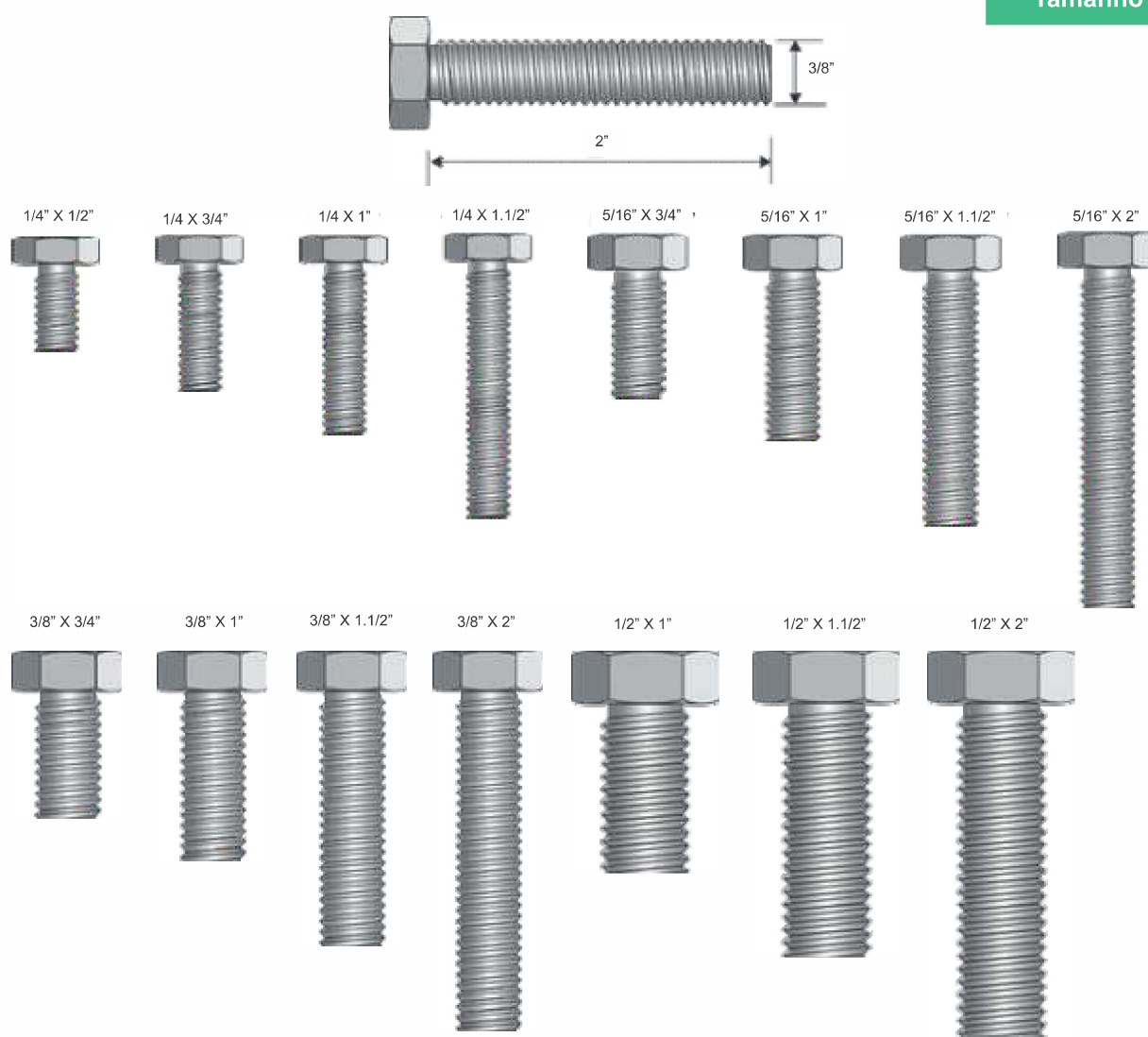

Todo parafuso de aço tem gravado em sua cabeça uma referência, que é o grau de dureza do aço.

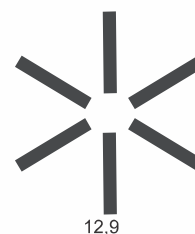
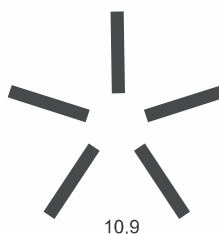
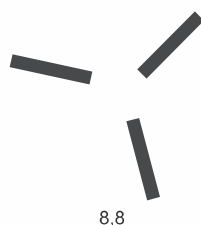

PARAFUSO SEXTAVADO - ROSCA PARCIAL

É utilizado em máquinas e equipamentos industriais, estruturas metálicas, veículos, móveis de aço e aplicações diversas.

O comprimento total não inclui a cabeça. É fornecido sem acabamento superficial.

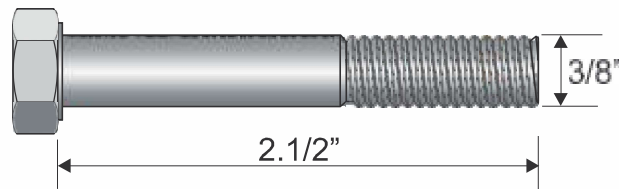

Escala 1:1
Tamanho real

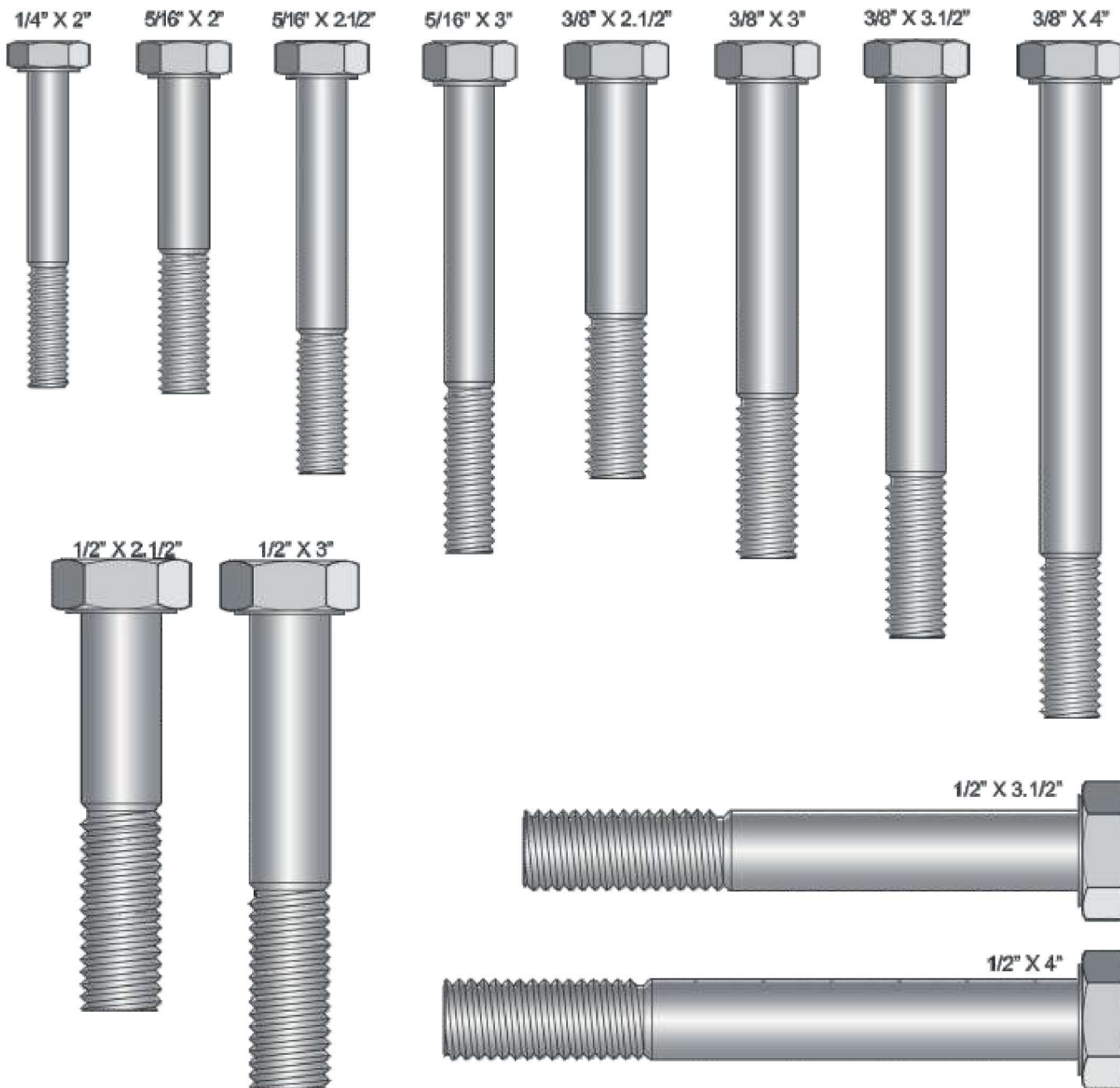



FIXADORES

PARAFUSO SEXTAVADO - ROSCA SOBERBA

Utilizado na fixação de portais, cercas, suportes para TV, vídeo, micro-ondas, etc. No concreto é utilizado com buchas de nylon.
O comprimento do parafuso não inclui a cabeça. É fornecido com acabamento superficial zincado branco.

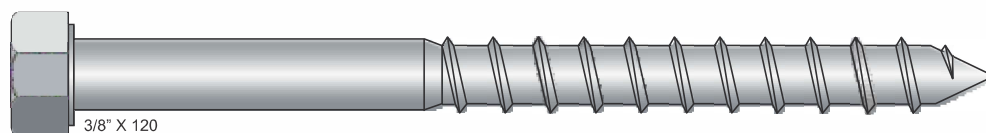
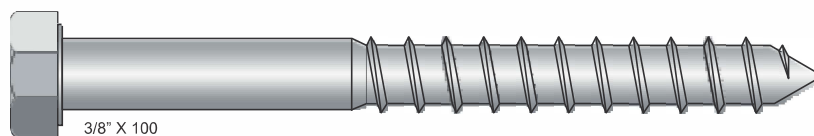
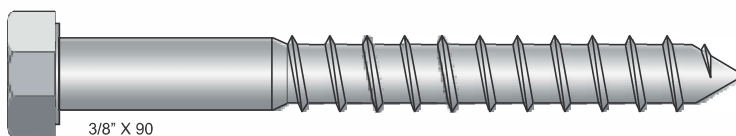
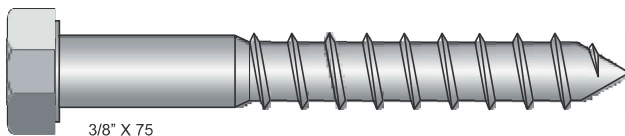
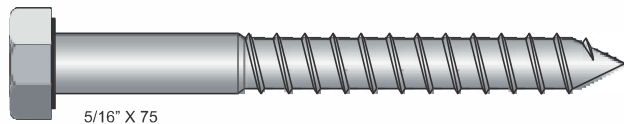
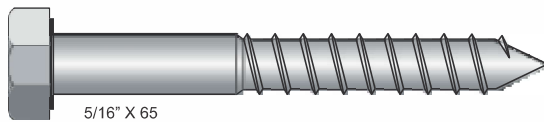
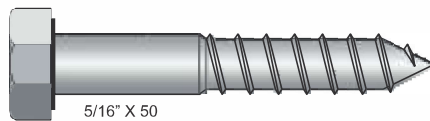
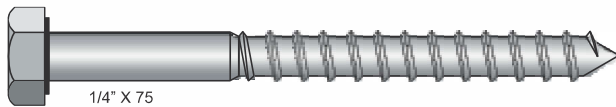
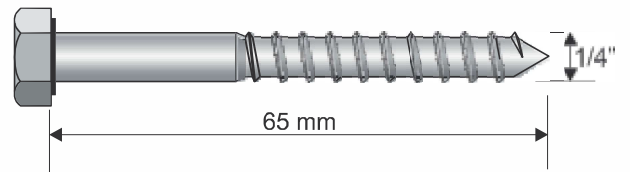
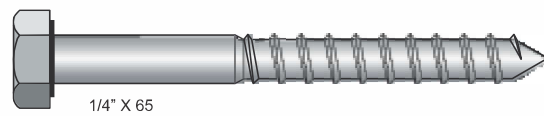
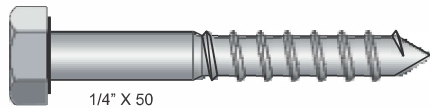

Escala 1:1
Tamanho real

COMPRIMENTO DA ROSCA

Para definir o comprimento aproximado da rosca na ausência de paquímetro ou escala usa-se a fórmula:

Diâmetro do parafuso x2 + 6,35
 Exemplo: 10 x 50mm, tamanho aproximado da rosca 26,35mm.

DEFINIÇÃO DE ROSCA

Total: quando todo o corpo do parafuso tem rosca
 Parcial: quando parte do corpo tem rosca

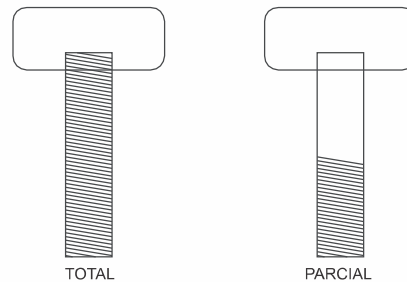

TIPOS DE ROSCA

Quando a norma usada for polegada, o tipo de rosca é definido tomando por base a quantidade de fios de rosca contido em 1 polegada.

UNC = Rosca Grossa
 UNF = Rosca Fina



Se a norma for métrica, o tipo de rosca é definido medindo-se a distância de um dente de rosca a outro.

MA = Rosca Grossa
 MB = Rosca Fina

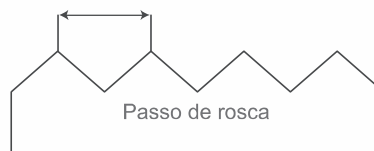

TIPOS DE CABEÇA

TIPOS DE FENDA

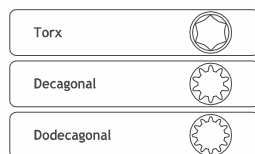
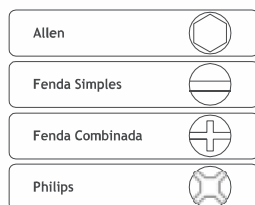

TIPOS DE CABEÇA

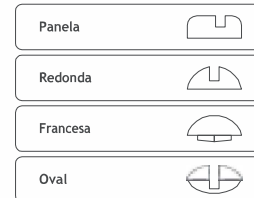
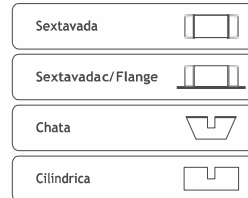

QUAL CHAVE USAR

Parafuso (mm)	Chave (mm)
2,5	5
3	5,5
4	7
5	8
6	10
8	13
10	17
12	19
14	22
16	27

Parafuso (pol)	Chave (pol)
1/8	1/4
5/32	1/4
3/16	5/16
1/4	3/8
5/16	1/2
3/8	9/16
7/16	5/8
1/2	3/4
9/16	7/8
5/8	15/16



FIXADORES

PARAFUSO SEXTAVADO - ROSCA SOBERBA

Belenus



CÓD.	DESCRIÇÃO	EMB.
21962	PARAF SEX R SOB A 3/16X40 BELE C/500	CX-5-CT
19542	PARAF SEX R SOB A 3/16X40 CISE C/200	CX-2-CT
16966	PARAF SEX R SOB A 3/16X45 BELE C/500	CX-5-CT
16747	PARAF SEX R SOB A 3/16X45 CISE C/200	CX-2-CT
17528	PARAF SEX R SOB A 3/16X50 BELE C/500	CX-5-CT
16748	PARAF SEX R SOB A 3/16X50 CISER	CX-2-CT
10766	PARAF SEX R SOB A 3/16X60 BELE C/200	CX-2-CT
16749	PARAF SEX R SOB A 3/16X60 CISER	CX-2-CT
10767	PARAF SEX R SOB A 3/16X70 BELE C/200	CX-2-CT
16142	PARAF SEX R SOB B 1/4X030 CISER C/200	CX-2-CT
20757	PARAF SEX R SOB B 1/4X040 BELE C/200	CX-2-CT
4244	PARAF SEX R SOB B 1/4X040 CISER	CX-2-CT
9699	PARAF SEX R SOB B 1/4X045 BELE C/200	CX-2-CT
4245	PARAF SEX R SOB B 1/4X045 CISER	CX-2-CT
16965	PARAF SEX R SOB B 1/4X050 BELE C/200	CX-2-CT
4246	PARAF SEX R SOB B 1/4X050 CISER	CX-2-CT
17512	PARAF SEX R SOB B 1/4X055 BELE C/200	CX-2-CT
4247	PARAF SEX R SOB B 1/4X055 CISER	CX-2-CT
16900	PARAF SEX R SOB B 1/4X060 BELE C/200	CX-2-CT
4248	PARAF SEX R SOB B 1/4X060 CISER	CX-2-CT
9703	PARAF SEX R SOB B 1/4X065 BELE C/100	CX-1-CT
4249	PARAF SEX R SOB B 1/4X065 CISE C/200	CX-2-CT
9903	PARAF SEX R SOB B 1/4X070 BELE C/100	CX-1-CT
4250	PARAF SEX R SOB B 1/4X070 CISER	CX-2-CT
9704	PARAF SEX R SOB B 1/4X075 BELE C/100	CX-1-CT

CÓD.	DESCRIÇÃO	EMB.
4251	PARAF SEX R SOB B 1/4X075 CISER	CX-2-CT
3249	PARAF SEX R SOB B 1/4X080 BELE C/100	CX-1-CT
3317	PARAF SEX R SOB B 1/4X090 BELE C/100	CX-1-CT
11189	PARAF SEX R SOB B 1/4X090 CISER	CX-1-CT
3318	PARAF SEX R SOB B 1/4X100 BELE C/100	CX-1-CT
11190	PARAF SEX R SOB B 1/4X100 CISER	CX-1-CT
20758	PARAF SEX R SOB B 5/16X040 BEL C/200	CX-2-CT
4252	PARAF SEX R SOB B 5/16X040 CISER	CX-2-CT
20759	PARAF SEX R SOB B 5/16X045 BEL C/200	CX-2-CT
4910	PARAF SEX R SOB B 5/16X050 BEL C/100	CX-1-CT
4254	PARAF SEX R SOB B 5/16X050 CISER	CX-2-CT
20309	PARAF SEX R SOB B 5/16X055 BEL C/200	CX-2-CT
4255	PARAF SEX R SOB B 5/16X055 CISER	CX-2-CT
9904	PARAF SEX R SOB B 5/16X060 BEL C/100	CX-1-CT
4256	PARAF SEX R SOB B 5/16X060 CISER	CX-2-CT
9907	PARAF SEX R SOB B 5/16X065 BEL C/100	CX-1-CT
4257	PARAF SEX R SOB B 5/16X065 CISER	CX-1-CT
9906	PARAF SEX R SOB B 5/16X070 BEL C/100	CX-1-CT
4258	PARAF SEX R SOB B 5/16X070 CISER	CX-1-CT
9905	PARAF SEX R SOB B 5/16X075 BEL C/100	CX-1-CT
4259	PARAF SEX R SOB B 5/16X075 CISER	CX-1-CT
3316	PARAF SEX R SOB B 5/16X080 BEL C/100	CX-1-CT
15876	PARAF SEX R SOB B 5/16X090 BEL C/100	CX-1-CT
11778	PARAF SEX R SOB B 5/16X090 CISEC/100	CX-1-CT
23525	PARAF SEX R SOB B 5/16X100 BEL C/100	CX-1-CT

CÓD.	DESCRIÇÃO	EMB.
11779	PARAF SEX R SOB B 5/16X100 CISER	CT
20760	PARAF SEX R SOB B 5/16X110 BEL C/100	CX-1-CT
19413	PARAF SEX R SOB B 5/16X115 CIS C/100	CX-1-CT
20815	PARAF SEX R SOB B 5/16X120 BEL C/100	CX-1-CT
3584	PARAF SEX R SOB B 5/16X130 CISER	CT
23992	PARAF SEX R SOB C 3/8X040 CISE C/200	CX-2-CT
11385	PARAF SEX R SOB C 3/8X050 CISE C/100	CX-1-CT
11386	PARAF SEX R SOB C 3/8X055 CISE C/100	CX-1-CT
4260	PARAF SEX R SOB C 3/8X060 CISE C/100	CX-1-CT
4261	PARAF SEX R SOB C 3/8X065 CISE C/100	CX-1-CT
4262	PARAF SEX R SOB C 3/8X070 CISE C/100	CX-1-CT
9708	PARAF SEX R SOB C 3/8X075 BELE C/100	CX-1-CT
4263	PARAF SEX R SOB C 3/8X075 CISE C/100	CX-1-CT
20761	PARAF SEX R SOB C 3/8X080 BELE C/100	CX-1-CT
4264	PARAF SEX R SOB C 3/8X080 CISE C/100	CX-1-CT
9709	PARAF SEX R SOB C 3/8X090 BELE C/100	CX-1-CT
4265	PARAF SEX R SOB C 3/8X090 CISE C/100	CX-1-CT
9710	PARAF SEX R SOB C 3/8X100 BELE C/100	CX-1-CT
4266	PARAF SEX R SOB C 3/8X100 CISE C/100	CX-1-CT
17513	PARAF SEX R SOB C 3/8X110 BELEN C/50	CX
4267	PARAF SEX R SOB C 3/8X115 CIS C/50	CX
17514	PARAF SEX R SOB C 3/8X120 BELEN C/50	CX
7034	PARAF SEX R SOB C 3/8X130 CISE C/50	CX

PITÃO



Zincado



Latonado

CÓD.	DESCRIÇÃO	EMB.
4318	PITAO LATONADO 14X30 S.RAPHAEL	CT
26015	PITAO LATONADO 14X30 WS CORRENTES	CT
9358	PITAO LATONADO 15X30 S.RAPHAEL	CT
26021	PITAO LATONADO 15X30 WS CORRENTES	CT
9359	PITAO LATONADO 16X30 S.RAPHAEL	CT
26026	PITAO LATONADO 16X30 WS CORRENTES	CT

CÓD.	DESCRIÇÃO	EMB.
9360	PITAO LATONADO 16X40 S.RAPHAEL	CT
26031	PITAO LATONADO 16X40 WS CORRENTES	CT
9361	PITAO LATONADO 17X40 S.RAPHAEL	CT
26042	PITAO LATONADO 17X40 WS CORRENTES	CT
9362	PITAO LATONADO 19X50 S.RAPHAEL	CT

CÓD.	DESCRIÇÃO	EMB.
26361	PITAO LATONADO 19X50 WS CORRENTES	CT
8524	PITAO P/BUCHA 06 C/100 S/B PARAFIX	CT
8525	PITAO P/BUCHA 08 C/100 S/B PARAFIX	CT
8526	PITAO P/BUCHA 10 C/100 S/B PARAFIX	CT
22687	PITAO P/BUCHA 12 C/100 S/B PARAFIX	CT

PARAFUSO VASO LATONADO



CÓD.	DESCRIÇÃO	EMB.
20374	PARAF VAS LATON 10 CAN PVC POR ZINCA C/20	PT
20375	PARAF VAS LATON 10 CAN/PORCA CROMADA C/20	PT

PARAFUSO TELHA

Belenus



CÓD.	DESCRIÇÃO	EMB.
20949	PARAF TELHA 5/16X110 MULTI-BARRAS COMP C/100	CX-1-CT
9774	PARAF TELHA 5/16X110 PARAF COM C/100	CX-1-CT
10216	PARAF TELHA 5/16X110 PARAF COMP BEL C/100	CX-1-CT
26638	PARAF TELHA 5/16X110 PARAF COMP CISER C/100	CX-1-CT

PORCA BORBOLETA



CÓD.	DESCRIÇÃO	EMB.
29278	PORCA BORBOLETA MA 05 CISER ZB C/500	CX-5-CT
29279	PORCA BORBOLETA MA 06 CISER ZB C/500	CX-5-CT
29280	PORCA BORBOLETA MA 08 CISER ZB C/200	CX-2-CT
29281	PORCA BORBOLETA MA 10 CISER ZB C/200	CX-2-CT
29277	PORCA BORBOLETA 1/2 CISER ZB UNC C/100	CX-1-CT
29274	PORCA BORBOLETA 1/4 CISER ZB UNC C/500	CX-5-CT
29273	PORCA BORBOLETA 3/16 CISER ZB UNC C/500	CX-5-CT
29276	PORCA BORBOLETA 3/8 CISER ZB UNC C/200	CX-2-CT
29275	PORCA BORBOLETA 5/16 CISER ZB UNC C/200	CX-2-CT

PARAFUSO/PORCA RODA



Parafuso Roda



Porca Roda

CÓD.	DESCRIÇÃO	EMB.
29450	PARAF RODA M12X1,25X27 8.8 FIAT CH 19 FEY ZB C/10	PT-10-PC
29365	PARAF RODA M12X1,50X22 10.9 GM FEY ZB C/10	PT-10-PC
29358	PARAF RODA M12X1,50X24 VW FEY ZB C/10	PT-10-PC
29522	PARAF RODA M12X1,50X28 VW FEY ZB C/10	PT-10-PC
29451	PARAF RODA M12X1,50X37/41 10.9 GM FEY ZB C/10	PT-10-PC
29452	PARAF RODA M12X1,50X37/41 10.9 S10 DIANT FEY ZB C/10	PT-10-PC
29349	PARAF RODA M12X1,50X38 HONDA FEY C/10	PT-10-PC
29556	PARAF RODA M12X1,50X41 10.9 FORD FEY ET C/10	PT-10-PC
29557	PARAF RODA M12X1,50X45,5 HYUNDAI FEY ZB C/10	PT-10-PC

CÓD.	DESCRIÇÃO	EMB.
29449	PARAF RODA M12X1,50X52/56 10.9 GM FEY ZB C/10	PT-10-PC
29407	PARAF RODA M12X1,5X36 COROLLA/FILDER TRAS FEY C/10	PT-10-PC
29496	PARAF RODA M12X1,5X40 COROLLA/FILDER DIANT FEY C/10	PT-10-PC
29353	PARAF RODA M12X44,5 HILUX TRASEIRA FEY C/10	PT-10-PC
29497	PARAF RODA M14X1,50X27 VW FEY ZB C/10	PT-10-PC
29352	PORCA RODA CL.8 M12 UNIV ALTA CH19 FEY CROM C/10	PT-10-PC
29351	PORCA RODA CL.8 M12 UNIV BAIXA CH19 FEY CROM C/10	PT-10-PC

CÓD.	DESCRIÇÃO	EMB.
29354	PORCA RODA CL.8 M12X1,50 COROLLA CH21 BAIXA FEY CROM C/10	PT-10-PC
29584	PORCA RODA CL.8 M12X1,50 FORD/GM/VW CH19 FEY C/10	PT-10-PC
29356	PORCA RODA CL.8 M12X1,50 HONDA CH19 FEY CROM C/10	PT-10-PC
29357	PORCA RODA CL.8 M12X1,50 KIA/HYUNDAI CH21 FEY CROM C/10	PT-10-PC
29355	PORCA RODA CL.8 M12X1,50 TOYOTA ALTA CH21 FEY CROM C/10	PT-10-PC
29350	PORCA RODA M12X1,50 UNIV VAZADA CH19 FEY ZB C/10	PT-10-PC

Conheça nossa
Nova linha
 de parafusos
 automotivos



E surpreenda-se
 com os preços





FIXADORES

SAIBA MAIS AQUI!

PORCAS E PARAFUSOS P/ CARROS

Código	Bitola	Aplicação	Cód. Fey	Imagem
29450	PARAF RODA M12X1,25X27 8.8 FIAT CH 19 FEY ZB C/10	Elba / Fiorino / Strada / Palio / Uno/ Marea / Tipo / Brava Tempera / Idea Siena / Punto - Dianteira e Traseira	800149	
29365	PARAF RODA M12X1,50X22 10.9 GM FEY ZB C/10	Corsa / Celta - 93../ Meriva / Tigra / Vectra / Zafira Dianteira e Traseira	800156	
29358	PARAF RODA M12X1,50X24 VW FEY ZB C/10	Passat / Voyage / Parati/ Gol (96 até o G7) Santana	815846	
29522	PARAF RODA M12X1,50X28 VW FEY ZB C/10	Santana / Gol GT / Copa - Dianteira e Traseira	800118	
29451	PARAF RODA M12X1,50X37/41 10.9 GM FEY ZB C/10	Opala/ Carava 1980... Chevette... - Dianteira e Traseira A10 / A20 / C10 / C20 / D10... - Dianteira e Traseira S10 / D20 - 1985.. - Dianteira	783435	
29452	PARAF RODA M12X1,50X37/41 10.9 S10 DIANT FEY ZB C/10	S10/12.. - Dianteira	820178	
29349	PARAF RODA M12X1,50X38 HONDA FEY C/10	City / Civic / Fit / CR-V / Accord	815860	
29556	PARAF RODA M12X1,50X41 10.9 FORD FEY ET C/10	Ka 09/13 / Courier 97/13/ Escort 84/99/ Verona /Fiesta 94/07/ Eco Sport 96/02 - Dianteira	797807	
29557	PARAF RODA M12X1,50X45,5 HYUNDAI FEY ZB C/10	Hb20 / Hb20S / Elantra / ix35 / Tucson / 130/ Azera / Genesis / Santa Fé / Veloster Accent / Sonata - Dianteira e Traseira	812418	
29449	PARAF RODA M12X1,50X52/56 10.9 GM FEY ZB C/10	Spin / Onix / Novo Prisma / Cobalt / Tracher Nova 2012.. - Dianteira	815877	
29407	PARAF RODA M12X1,5X36 COROLLA/FILDER TRAS FEY C/10	Corolla / Fielder - Traseira	816881	
29496	PARAF RODA M12X1,5X40 COROLLA/FILDER DIANT FEY C/10	Corolla / Fielder / Hilux (05/...) / SW4 (05/...) - Dianteira	816898	
29353	PARAF RODA M12X44,5 HILUX TRASEIRA FEY C/10	Hilux (todas) / SW4 (12/...) - Traseira	815921	
29497	PARAF RODA M14X1,50X27 VW FEY ZB C/10	VW: Fox / Polo / Jetta / Golf e Tiguan Audi: A3 / A4 / A6 / TT	815853	
29352	PORCA RODA CL.8 M12 UNIV ALTA CH19 FEY CROM C/10	Spin / Onix / Novo Prisma / Cobalt / Captiva / Cruze / Trailblazer / S10 (12../) Tracker (13/...)	90519	
29351	PORCA RODA CL.8 M12 UNIV BAIXA CH19 FEY CROM C/10	Ford: Fiesta / Ka / Focus / Ecosport GM: Opala / D20 / S10/ VW: Logus	88578	
29354	PORCA RODA CL.8 M12X1,50 COROLLA CH21 BAIXA FEY CROM C/10	Mitsubishi: L200 Triton 2007/ Toyota: Hilux (.../04) / Corolla (03/07)/ Etios	90977	
29584	PORCA RODA CL.8 M12X1,50 FORD/ GM/VW CH19 FEY C/10	Ford: Fiesta / Ka / Focus / Ecosport GM: Opala / D20 / S10 / VW: Logus	88554	
29356	PORCA RODA CL.8 M12X1,50 HONDA CH19 FEY CROM C/10	Honda: Accord / City / Civic / Fit / CR-V	92483	
29357	PORCA RODA CL.8 M12X1,50 KIA/ HYUNDAI CH21 FEY CROM C/10	Hyundai: Hb20 / H100 / ix35... / Kia: Besta / Cerato/ Sportage... / Mitsubishi: L200 (92/07) / L300/ (95/00)	92476	
29355	PORCA RODA CL.8 M12X1,50 TOYOTA ALTA CH21 FEY CROM C/10	Corolla (08/...) / Hilux (05/...) / SW4(05...) / RAV 4	90502	
29350	PORCA RODA M12X1,50 UNIV VAZADA CH19 FEY ZB C/10	GM: Opala (80/...) / Chevette / D20../ Ford: todos	37378	

PORCA SEXTAVADA - AUTOTRAVANTE



CÓD.	DESCRIÇÃO	EMB.
7948	PORCA SEXT D M04MA AUT TR ZB BEL C/2000	CX-20-CT
7945	PORCA SEXT D M05MA AUT TRAV ZB BEL C/2000	CX-20-CT
16183	PORCA SEXT D M06MA AUT TR BEL C/1000	CX-10-CT
16184	PORCA SEXT D M08MA AUT TR BEL C/500	CX-5-CT
29176	PORCA SEXT D M08MA AUT TRAV C.8C/1000	CX-10-CT
16185	PORCA SEXT D M10MA AUT TR BEL C/500	CX-5-CT
24085	PORCA SEXT D M10MA AUT TRAV C.8 C500...	CX-5-CT
16186	PORCA SEXT D M12MA AUT TR BEL C/200	CX-2-CT
24086	PORCA SEXT D M12MA AUT TRAV C.8 C500	CX-5-CT
16187	PORCA SEXT D M14MA AUT TR BEL C/200	CX-2-CT
16188	PORCA SEXT D M16MA AUT TR BEL C/100	CX-1-CT
24088	PORCA SEXT D M16MA AUT TRAV C.8 C100	CT
6361	PORCA SEXT D M18MA AUT TR BEL C/100	CX-1-CT
6362	PORCA SEXT D M20MA AUT TR BEL C/100	CX-1-CT

CÓD.	DESCRIÇÃO	EMB.
6291	PORCA SEXT D M20MA AUT TRAV C.8 C100	CT
7979	PORCA SEXT D M22MA AUT TR BEL ZB C/50	CX-0,5-CT
7978	PORCA SEXT D M24MA AUT TR BEL ZB C/50	CX-0,5-CT
14723	PORCA SEXT D UNC AUT TR D 1/4 C/1000	CX-10-CT
16189	PORCA SEXT D UNC AUT TR D 1/4BC/1000	CX-10-CT
16190	PORCA SEXT D UNC AUT TR E 5/16 RG BE	CX-5-CT
14724	PORCA SEXT D UNC AUT TR E 5/16C/1000...	CX-10-CT
9980	PORCA SEXT D UNC AUT TR F 3/8 C/500	CX-5-CT
16191	PORCA SEXT D UNC AUT TR F 3/8 RG BEL	CX-5-CT
9979	PORCA SEXT D UNC AUT TR G 7/16 C/200	CX-2-CT
16192	PORCA SEXT D UNC AUT TR G 7/16 RG BE	CX-5-CT
9978	PORCA SEXT D UNC AUT TR H 1/2 C/200	CX-2-CT
16193	PORCA SEXT D UNC AUT TR H 1/2 RG BEL	CX-2-CT
7690	PORCA SEXT D UNC AUT TR I 3/4 G2 C/100	CX-1-CT

CÓD.	DESCRIÇÃO	EMB.
23005	PORCA SEXT D UNC AUT TR I 9/16 C/100	CX-1-CT
7992	PORCA SEXT D UNC AUT TR J 3/4 RG BEL C/100	CT
23006	PORCA SEXT D UNC AUT TR J 3/4 RG BEL C/100	CT
27128	PORCA SEXT D UNC AUT TR J 5/8 RG BEL	CT
7976	PORCA SEXT D UNC AUT TR J 7/8 RG BEL C/50	CX-0,5-CT
7692	PORCA SEXT D UNC AUT TR M 1 G2 C/50	CX
6290	PORCA SEXT D M18MA AUT TRAV C.8 C100	CT
19779	PORCA SEXT E M12MB AUT TR BELE C/200	CX-2-CT
19780	PORCA SEXT E M14MB AUT TR BELE C/200	CX-2-CT
24577	PORCA SEXT E M14MB AUT TRAV C.8C/100...	CT
16194	PORCA SEXT E M16MB AUT TR ZI BEC/100	CX-2-CT
15913	PORCA SEXT E M18MB AUT TRAV C.8 C100...	CT

PORCA SEXTAVADA ROSCA FINA - MILÍMETRO/POLEGADA



CÓD.	DESCRIÇÃO	EMB.
25903	PORCA SEXT B M08MB ROSCA FINA C/500	CX-5-CT
12590	PORCA SEXT B M10MB ROSCA FINA C/500	CX-5-CT
18154	PORCA SEXT B M12MB ACO R.F C8 C/200	CX-2-CT
16159	PORCA SEXT B M12MB BELENUS C/200	CX-2-CT
12591	PORCA SEXT B M12MB R F C/200	CX-2-CT
18252	PORCA SEXT B M14MB ACO R.F C.8 C/200	CX-2-CT

CÓD.	DESCRIÇÃO	EMB.
16160	PORCA SEXT B M14MB BELENUS C/200	CX-2-CT
12592	PORCA SEXT B M14MB R FINA C/200	CX-2-CT
12593	PORCA SEXT B M16MB R FINA C/100	CX-1-CT
20754	PORCA SEXT B M16MB RF BELENUS C/100	CT
12594	PORCA SEXT B UNF E 5/16 R F C/500	CX-5-CT
28224	PORCA SEXT B UNF F 1/2 ZINC RF C/200	CX-2-CT

CÓD.	DESCRIÇÃO	EMB.
28223	PORCA SEXT B UNF F 1/4 RF C1000	CX-5-CT
28221	PORCA SEXT B UNF F 3/16 ZINC RFC2000	CX-20-CT
12595	PORCA SEXT B UNF F 3/8 R F C/500	CX-5-CT
12597	PORCA SEXT B UNF H 1/2 R F C/200	CX-2-CT
12598	PORCA SEXT B UNF 19/16 R F C/200	CX-2-CT
23899	PORCA SEXT B UNF J 5/8 R F C/100	CX-1-CT

PORCA SEXTAVADA ROSCA GROSSA - MILÍMETRO/POLEGADA



CÓD.	DESCRIÇÃO	EMB.
16161	PORCA SEXT A M04MA R.G BELENU C/2000	CX-20-CT
12589	PORCA SEXT A M04MA ROSCA GROS C/2000	CX-20-CT
16162	PORCA SEXT A M05MA GROS BELEN C/2000	CX-20-CT
4395	PORCA SEXT A M05MA ROSCA GROS C/2000	CX-20-CT
20183	PORCA SEXT A M06MA ACO C8 BEL C/1000	CX-10-CT
18150	PORCA SEXT A M06MA ACO R.G C8 C/1000	CX-10-CT
16543	PORCA SEXT A M06MA RG BELENUS C/1000	CX-10-CT
4396	PORCA SEXT A M06MA ROSCA GROS C/1000	CX-10-CT
20185	PORCA SEXT A M08MA ACO C8 BELE C/500	CX-5-CT
18151	PORCA SEXT A M08MA ACO R.G C8 C/500	CX-5-CT
16163	PORCA SEXT A M08MA RG BELENUS C/500	CX-5-CT
4397	PORCA SEXT A M08MA ROSCA GROS C/500	CX-5-CT
20186	PORCA SEXT A M10MA ACO C8 BELE C/500	CX-5-CT
18152	PORCA SEXT A M10MA ACO R.G C8 C/500	CX-5-CT
16157	PORCA SEXT A M10MA RG BELENUS C/500	CX-5-CT
4398	PORCA SEXT A M10MA ROSCA GROS C/500	CX-5-CT
20187	PORCA SEXT A M12MA ACO C8 BELE C/200	CX-2-CT
18153	PORCA SEXT A M12MA ACO R.G C8 C/200	CX-2-CT
16158	PORCA SEXT A M12MA RG BELENUS C/200	CX-2-CT
4399	PORCA SEXT A M12MA ROSCA GROS C/200	CX-2-CT
20188	PORCA SEXT A M14MA ACO C.8 BEL C/200	CX-2-CT
18250	PORCA SEXT A M14MA ACO R.G C8 C/200	CX-2-CT
16164	PORCA SEXT A M14MA RG BELENUS C/200	CX-2-CT
5166	PORCA SEXT A M14MA ROSCA GROS C/200	CX-2-CT

CÓD.	DESCRIÇÃO	EMB.
20250	PORCA SEXT A M16MA ACO C.8 BEL C/100	CX-1-CT
18251	PORCA SEXT A M16MA ACO R.G C8 C/200	CX-2-CT
16165	PORCA SEXT A M16MA RG BELENUS C/100	CX-1-CT
12993	PORCA SEXT A M16MA ROSCA GROS C/100	CX-1-CT
20334	PORCA SEXT A M18MA ACO R.G C8 C/100	CX-1-CT
15208	PORCA SEXT A M18MA RG BELENUS C/100	CX-1-CT
11380	PORCA SEXT A M18MA ROSCA GROS C/100	CX-1-CT
15207	PORCA SEXT A M20MA RG BELENUS C/100	CX-1-CT
11381	PORCA SEXT A M20MA ROSCA GROS C/100	CX-1-CT
15211	PORCA SEXT A M24MA RG BELENUS C/50	CX
16166	PORCA SEXT A N 5/32 BELEN C/2000	CX-20-CT
6293	PORCA SEXT A UNC A 5/32 R G C/2000	CX-20-CT
16167	PORCA SEXT A UNC C 3/16 BELEN C/2000	CX-20-CT
4402	PORCA SEXT A UNC C 3/16 R G C/2000	CX-20-CT
22679	PORCA SEXT A UNC D 1/4 ACO G5 C/1000	CX-10-CT
21658	PORCA SEXT A UNC D 1/4 ACO G5 C/1000	CX-10-CT
233	PORCA SEXT A UNC D 1/4 BELENU C/1000...	CX-10-CT
4403	PORCA SEXT A UNC D 1/4 RG C/1000	CX-10-CT
20191	PORCA SEXT A UNC E 5/16 AC G5 BC/500	CX-5-CT
16168	PORCA SEXT A UNC E 5/16 BELENU C/500	CX-5-CT
4404	PORCA SEXT A UNC E 5/16 R G C/500	CX-5-CT
20755	PORCA SEXT A UNC F 3/8 ACO G5 BC/500	CX-5-CT
16489	PORCA SEXT A UNC F 3/8 BELENUS C/500	CX-5-CT
29032	PORCA SEXT A UNC F 3/8 R G C/500...	CX-5-CT

CÓD.	DESCRIÇÃO	EMB.
4406	PORCA SEXT A UNC G 7/16 R G C/500	CX-5-CT
20364	PORCA SEXT A UNC H 1/2 ACO G5 BC/200	CX-2-CT
16163	PORCA SEXT A UNC H 1/2 BELENUS C/200	CX-2-CT
4407	PORCA SEXT A UNC H 1/2 R G C/200	CX-2-CT
16170	PORCA SEXT A UNC I 19/16 BELENU C/200	CX-2-CT
4408	PORCA SEXT A UNC I 19/16 R G C/200	CX-2-CT
20192	PORCA SEXT A UNC J 5/8 ACO G5 BC/100	CX-1-CT
18160	PORCA SEXT A UNC J 5/8 ACO G5 C/100	CX-1-CT
4409	PORCA SEXT A UNC J 5/8 R G C/100	CX-1-CT
16171	PORCA SEXT A UNC J 5/8 RG BELE C/100	CX-1-CT
16172	PORCA SEXT A UNC K 3/4 BELENU C/100	CX-1-CT
20193	PORCA SEXT A UNC K 3/4 ACO G5 BC/100	CX-1-CT
4410	PORCA SEXT A UNC K 3/4 R G C/100	CX-1-CT
16174	PORCA SEXT A UNC L 7/8 BELENUS C/50	CX
4411	PORCA SEXT A UNC L 7/8 R G C/50	CX
16175	PORCA SEXT A UNC M 1 BELENUS C/50	CX
16548	PORCA SEXT A UNC M 1.1/8 BELENU C/20	CX
16547	PORCA SEXT A UNC N 1.1/4 BELENU C/20	CX
26254	PORCA SEXT A UNC N 1.3/4 BELENU C/10	CX
16181	PORCA SEXT A UNC O 1.1/2 BELENU C/20	CX
8248	PORCA SEXT A UNC 5/32 R G C/2000	CX-20-CT
29229	PORCA SEXT A UNC J 5/8 RG BELENUS ZB C/100	CX-1-CT
16545	PORCA SEXT B BSW 1/8 BELENUS C/20	CX-20-CT
4400	PORCA SEXT B BSW 1/8 C/2000	CX-20-CT



FIXADORES

PORCA SEXTAVADA - DUPLA



CÓD.	DESCRIÇÃO	EMB.
16195	PORCA SEXT F M18MB DUPLA R.F BE C100	CX-1-CT
16197	PORCA SEXT F UNF DUPLA J 5/8 BEC/100	CX-1-CT
16196	PORCA SEXT F UNF DUPLA H 1/2 RF BELE	CX-2-CT

PORCA SEXTAVADA ROSCA GROSSA - ZINCADA



CÓD.	DESCRIÇÃO	EMB.
27124	PORCA SEXT C M06MA ZINC RO GR BC1000	CX-10-CT
26362	PORCA SEXT C M06MA ZINC ROS GR C1000	CX-10-CT
27125	PORCA SEXT C M08MA ZINC ROS GR BC500	CX-5-CT
26363	PORCA SEXT C M08MA ZINC ROS GR C/500	CX-5-CT
27126	PORCA SEXT C M10MA ZINC ROS GR BC500	CX-5-CT
26360	PORCA SEXT C M10MA ZINC ROS GR C/500	CX-5-CT
14446	PORCA SEXT C M12MA ZINC R G C/200	CX-2-CT
27127	PORCA SEXT C M12MA ZINC ROS GR BC200	CX-2-CT
27924	PORCA SEXT C UNC ZC A 5/32 RG C/2000	CX-20-CT
15651	PORCA SEXT C UNC ZC B 3/16 RG C/2000	CX-20-CT

CÓD.	DESCRIÇÃO	EMB.
16546	PORCA SEXT C UNC ZC D 1/4 BELEC/1000	CX-10-CT
8331	PORCA SEXT C UNC ZC D 1/4 RG C/1000	CX-10-CT
130	PORCA SEXT C UNC ZC E 5/16 BEL C/500	CX-5-CT
10147	PORCA SEXT C UNC ZC E 5/16 RG C/500	CX-5-CT
16180	PORCA SEXT C UNC ZC F 3/8 BELE C/500	CX-5-CT
10507	PORCA SEXT C UNC ZC F 3/8 RG C/500	CX-5-CT
25514	PORCA SEXT C UNC ZC F 7/16 BELE C500	CX-5-CT
16154	PORCA SEXT C UNC ZC H 1/2 BELE C/200	CX-2-CT
10508	PORCA SEXT C UNC ZC H 1/2 RG C/200	CX-2-CT

PORCA SEXTAVADA - ROSCA UNC

Escala 1:1
Tamanho real

É utilizada em qualquer fixador, desde que a rosca e a resistência sejam compatíveis.

A medida da porca é definida por:

- O primeiro número equivale a bitola da porca e refere-se ao diâmetro do parafuso (ou diâmetro interno da porca).
- O segundo número equivale a chave e refere-se a medida entre duas faces paralelas da porca.

É fornecida com acabamento polido (oleado).



Bitola 3/16"



Chave 5/16"

Bitola 1/4"



Chave 7/16"

Bitola 5/16"

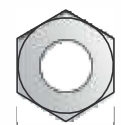

Chave 1/2"

Bitola 3/8"



Chave 9/16"

Bitola 1/2"

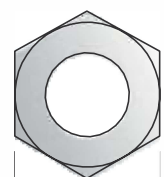
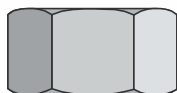

Chave 3/4"

Bitola 1/2"
Rosca BSW

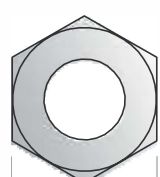
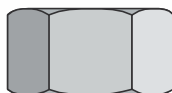

Chave 3/4"

Bitola 5/8"

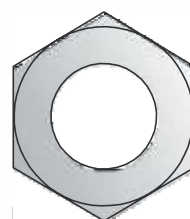
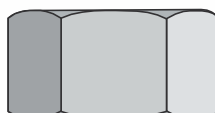

Chave 15/16"

Bitola 3/4"

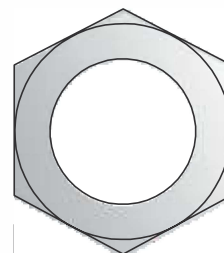
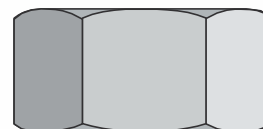

Chave 1.1/8"

DICA DO REI

PREGOS

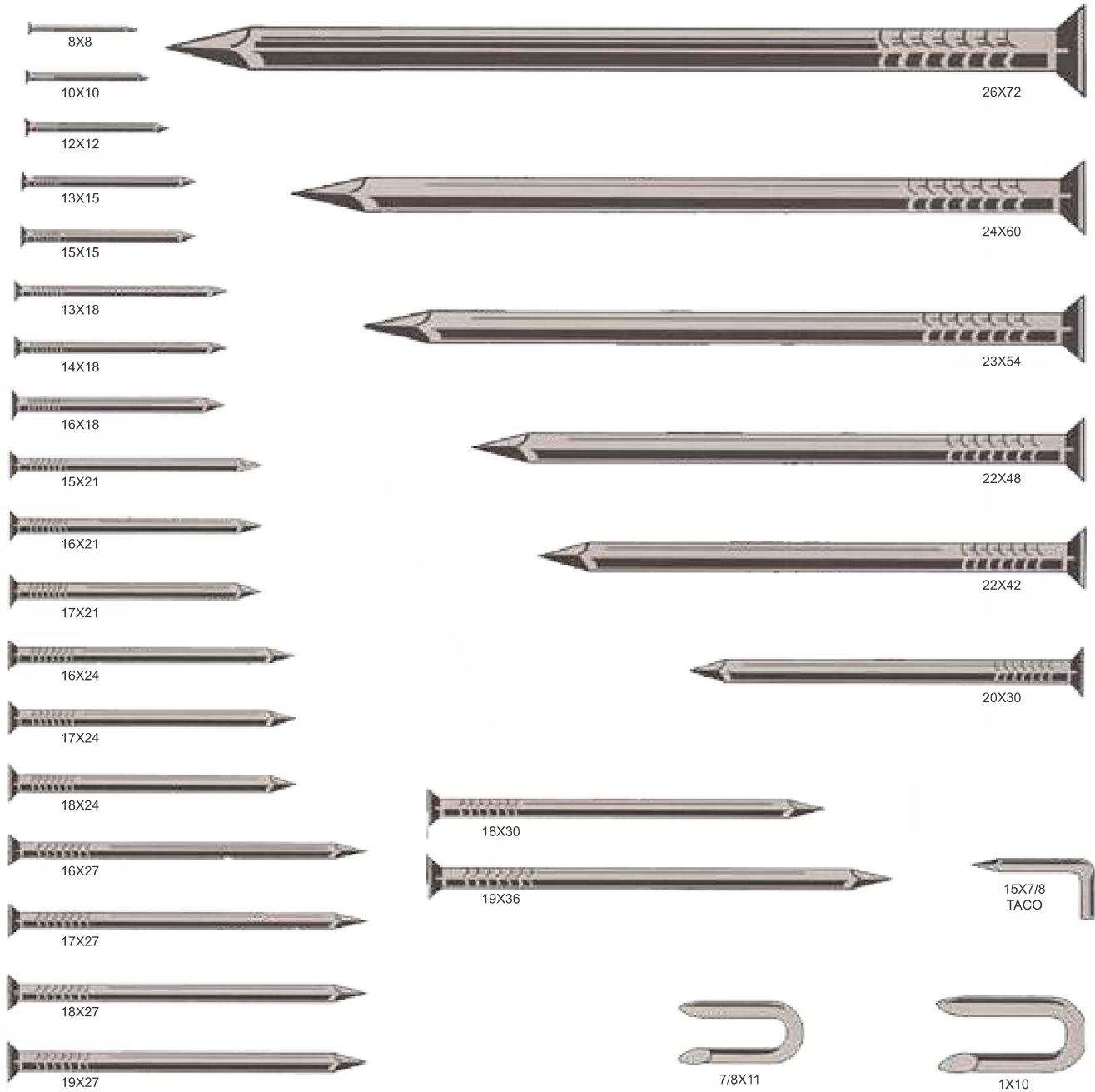



FIXADORES

PREGO COM CABEÇA



Preço com cabeça

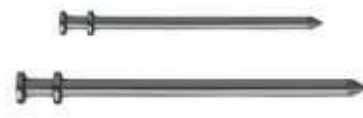

Preço cabeça dupla

CÓD.	DESCRIÇÃO	EMB.
4453	PREGO COM CABECA 08X08 @#	KG
4454	PREGO COM CABECA 10X10 @#	KG
4455	PREGO COM CABECA 12X12 @#	KG
19063	PREGO COM CABECA 12X12 NEWFIX @#	KG
4456	PREGO COM CABECA 13X15 @#	KG
19065	PREGO COM CABECA 13X15 NEWFIX @#	KG
4457	PREGO COM CABECA 13X18 @#	KG
19075	PREGO COM CABECA 13X18 NEWFIX @#	KG
19076	PREGO COM CABECA 14X18 NEWFIX @#	KG
4458	PREGO COM CABECA 15X15 @#	KG
19658	PREGO COM CABECA 15X15 NEWFIX/MB @#	KG
19658	PREGO COM CABECA 15X15 NEWFIX/MB @#	KG
5464	PREGO COM CABECA 15X21 @#	KG
19661	PREGO COM CABECA 15X21 NEWFIX/MB @#	KG
7483	PREGO COM CABECA 16X21 @#	KG
19665	PREGO COM CABECA 16X21 NEWFIX/MB @#	KG
19801	PREGO COM CABECA 16X24 @#	KG
21533	PREGO COM CABECA 16X24 NEWFIX/MB @#	KG
21533	PREGO COM CABECA 16X24 NEWFIX/MB @#	KG
23410	PREGO COM CABECA 16X27 @#	KG
19373	PREGO COM CABECA 16X27 NEWFIX/MB @#	KG
4440	PREGO COM CABECA 17X21 @#	KG

CÓD.	DESCRIÇÃO	EMB.
19361	PREGO COM CABECA 17X21 NEWFIX/MB @#	KG
19361	PREGO COM CABECA 17X21 NEWFIX/MB @#	KG
5753	PREGO COM CABECA 17X24 @#	KG
19077	PREGO COM CABECA 17X24 NEWFIX/MB @#	KG
5465	PREGO COM CABECA 17X27 @#	KG
17410	PREGO COM CABECA 17X27 DUPLA @#	KG
19080	PREGO COM CABECA 17X27 NEWFIX/MB @#	KG
4442	PREGO COM CABECA 18X24 @	KG
19078	PREGO COM CABECA 18X24 NEWFIX/MB @#	KG
19078	PREGO COM CABECA 18X24 NEWFIX/MB @#	KG
19078	PREGO COM CABECA 18X24 NEWFIX/MB @#	KG
4443	PREGO COM CABECA 18X27 @#	KG
19666	PREGO COM CABECA 18X27 NEWFIX/MB @#	KG
19666	PREGO COM CABECA 18X27 NEWFIX/MB @#	KG
19666	PREGO COM CABECA 18X27 NEWFIX/MB @#	KG
4444	PREGO COM CABECA 18X30 @#	KG
19659	PREGO COM CABECA 18X30 NEWFIX/MB @#	KG
19659	PREGO COM CABECA 18X30 NEWFIX/MB @#	KG
4445	PREGO COM CABECA 18X36 @#	KG
19365	PREGO COM CABECA 18X36 NEWFIX/MB @#	KG
4446	PREGO COM CABECA 19X27 @#	KG
19363	PREGO COM CABECA 19X27 NEWFIX/MB @#	KG

CÓD.	DESCRIÇÃO	EMB.
19363	PREGO COM CABECA 19X27 NEWFIX/MB @#	KG
4447	PREGO COM CABECA 19X36 @#	KG
19667	PREGO COM CABECA 19X36 NEWFIX/MB @#	KG
19667	PREGO COM CABECA 19X36 NEWFIX/MB @#	KG
24774	PREGO COM CABECA 19X42 @	KG
26121	PREGO COM CABECA 19X42 NEWFIX/MB @#	KG
26121	PREGO COM CABECA 19X42 NEWFIX/MB @#	KG
4448	PREGO COM CABECA 20X30 @#	KG
19081	PREGO COM CABECA 20X30 NEWFIX/MB @#	KG
19081	PREGO COM CABECA 20X30 NEWFIX/MB @#	KG
19081	PREGO COM CABECA 20X42 @#	KG
19084	PREGO COM CABECA 20X42 NEWFIX/MB @#	KG
19084	PREGO COM CABECA 20X42 NEWFIX/MB @#	KG
19084	PREGO COM CABECA 20X42 NEWFIX/MB @#	KG
4450	PREGO COM CABECA 22X42 @#	KG
4451	PREGO COM CABECA 22X48 @#	KG
4452	PREGO COM CABECA 26X72 @#	KG
6191	PREGO COM CABECA 26X78 @#	KG
10819	PREGO COM CABECA 14X18 @#	KG
17409	PREGO COM CABECA 18X27 DUPLA @#	KG

PREGO SEM CABEÇA



CÓD.	DESCRIÇÃO	EMB.
5706	PREGO SEM CABECA 10X10 @#	KG
5707	PREGO SEM CABECA 12X12 @#	KG
5708	PREGO SEM CABECA 13X15 @#	KG
5709	PREGO SEM CABECA 13X18 @#	KG
5710	PREGO SEM CABECA 15X15 @#	KG
5711	PREGO SEM CABECA 15X21 @	KG
3363	PREGO SEM CABECA 16X21 @#	KG
11244	PREGO SEM CABECA 16X24 @#	KG

PREGO TELHEIRO



CÓD.	DESCRIÇÃO	EMB.
9847	PREGO TELHA GALV 18X27 MULTILIT C/ 500GR	PT
15244	PREGO TELHA GALV 18X27TORCID 53PC @	PT
18164	PREGO TELHA GALV 18X30 MULTILIT C/500GR	PT
9825	PREGO TELHA GALV 18X36 MULTILIT C/500GR	PT

TACHINHA



CÓD.	DESCRIÇÃO	EMB.
12311	TACHINHA BRAFT 06 C/100	CX
12312	TACHINHA BRAFT 08 C/100	CX
12313	TACHINHA BRAFT 10 C/100	CX
12314	TACHINHA BRAFT 12 C/100	CX

REBITE



CÓD.	DESCRIÇÃO	EMB.
19555	REBITE FIX-ALL 306 RM306 C/1000	MI
19556	REBITE FIX-ALL 308 RM308 C/1000	MI
19557	REBITE FIX-ALL 310 RM310 C/1000	MI
19182	REBITE FIX-ALL 312 RM312 C/1000	MI
19558	REBITE FIX-ALL 314 RM314 C/1000	MI
19559	REBITE FIX-ALL 316 RM316 C/1000	MI
19560	REBITE FIX-ALL 319 RM319 C/1000	MI
19562	REBITE FIX-ALL 325 RM325 C/1000	MI
19564	REBITE FIX-ALL 410 RM410 C/1000	MI
19563	REBITE FIX-ALL 412 RM412 C/1000	MI
19565	REBITE FIX-ALL 414 RM414 C/1000	MI
19566	REBITE FIX-ALL 416 RM416 C/1000	MI
19567	REBITE FIX-ALL 419 RM419 C/1000	MI
19568	REBITE FIX-ALL 422 RM422 C/1000	MI
19569	REBITE FIX-ALL 425 RM425 C/1000	MI
19571	REBITE FIX-ALL 512 RM512 C/1000	MI
19572	REBITE FIX-ALL 514 RM514 C/1000	MI
19573	REBITE FIX-ALL 516 RM516 C/1000	MI
19655	REBITE FIX-ALL 519 RM519 C/1000	MI
19574	REBITE FIX-ALL 522 RM522 C/1000	MI
19575	REBITE FIX-ALL 525 RM525 C/1000	MI
19576	REBITE FIX-ALL 530 RM530 C/0500	CX
19577	REBITE FIX-ALL 535 RM535 C/0500	CX

CÓD.	DESCRIÇÃO	EMB.
19578	REBITE FIX-ALL 540 RM540 C/0500	CX
19580	REBITE FIX-ALL 614 RM614 C/0500	CX
19656	REBITE FIX-ALL 616 RM616 C/0500	CX
27873	REBITE FIX-ALL 619 RM619 C/0500	CX
19581	REBITE FIX-ALL 622 RM622 C/0500	CX
19582	REBITE FIX-ALL 625 RM625 C/0500	CX
19583	REBITE FIX-ALL 630 RM630 C/0500	CX
27874	REBITE FIX-ALL 635 RM635 C/0500	CX
20376	REBITE 3,2X06 306 BELENUS C/1000...	CX
27487	REBITE 3,2X08 308 BELENUS C/1000...	CX
20663	REBITE 3,2X10 310 BELENUS C/1000...	CX
20664	REBITE 3,2X12 312 BELENUS C/1000...	CX
26237	REBITE 3,2X14 314 BELENUS C/1000...	ML-1-CX
26238	REBITE 3,2X16 316 BELENUS C/1000...	ML-1-CX
27486	REBITE 3,2X19 319 BELENUS C/1000...	CX
20379	REBITE 3,2X25 325 BELENUS C/0500	CX
20377	REBITE 4,0X10 410 BELENUS C/1000...	CX
20381	REBITE 4,0X12 412 BELENUS C/1000...	CX
26239	REBITE 4,0X14 414 BELENUS C/0500...	CX
26240	REBITE 4,0X16 416 BELENUS C/0500...	CX
27953	REBITE 4,0X19 419 BELENUS C/0500	CX
20382	REBITE 4,0X22 422 BELENUS C/0500	CX
20315	REBITE 4,0X25 425 BELENUS C/0500	CX

CÓD.	DESCRIÇÃO	EMB.
20385	REBITE 4,8X12 512 BELENUS C/0500...	CX
20316	REBITE 4,8X14 514 BELENUS C/0500...	CX
20387	REBITE 4,8X16 516 BELENUS C/0500	CX
20387	REBITE 4,8X16 516 BELENUS C/0500	CX
20317	REBITE 4,8X19 519 BELENUS C/0500...	CX
21858	REBITE 4,8X22 522 BELENUS C/0250...	CX
20318	REBITE 4,8X25 525 BELENUS C/0250...	CX
20319	REBITE 4,8X30 530 BELENUS C/0250...	CX
20320	REBITE 4,8X35 535 BELENUS C/0200	CX
20321	REBITE 4,8X40 540 BELENUS C/0150	CX
27954	REBITE 6,0X30 630 BELENUS C/0200	CX
27963	REBITE 6,0X35 635 BELENUS C/0200	CX
26241	REBITE 6,2X14 614 BELENUS C/0350	CX
26242	REBITE 6,2X16 616 BELENUS C/0350	CX
26242	REBITE 6,2X16 616 BELENUS C/0350	CX
20390	REBITE 6,2X19 619 BELENUS C/0300	CX
20665	REBITE 6,2X22 622 BELENUS C/0250	CX
20794	REBITE 6,2X25 625 BELENUS C/0250	CX
26267	REBITE 6,2X35 635 BELENUS C/0200	CX
20323	REBITE 6,2X40 640 BELENUS C/0150	CX